

SUPER[®]

SUPER[®] X8DTL-3

SUPER[®] X8DTL-i

SUPER[®] X8DTL-3F

SUPER[®] X8DTL-iF

USER'S MANUAL

Revision 1.2a

The information in this User's Manual has been carefully reviewed and is believed to be accurate. The vendor assumes no responsibility for any inaccuracies that may be contained in this document, makes no commitment to update or to keep current the information in this manual, or to notify any person or organization of the updates. **Please Note: For the most up-to-date version of this manual, please see our web site at www.supermicro.com.**

Super Micro Computer, Inc. ("Supermicro") reserves the right to make changes to the product described in this manual at any time and without notice. This product, including software and documentation, is the property of Supermicro and/or its licensors, and is supplied only under a license. Any use or reproduction of this product is not allowed, except as expressly permitted by the terms of said license.

IN NO EVENT WILL SUPERMICRO BE LIABLE FOR DIRECT, INDIRECT, SPECIAL, INCIDENTAL, SPECULATIVE OR CONSEQUENTIAL DAMAGES ARISING FROM THE USE OR INABILITY TO USE THIS PRODUCT OR DOCUMENTATION, EVEN IF ADVISED OF THE POSSIBILITY OF SUCH DAMAGES. IN PARTICULAR, SUPERMICRO SHALL NOT HAVE LIABILITY FOR ANY HARDWARE, SOFTWARE, OR DATA STORED OR USED WITH THE PRODUCT, INCLUDING THE COSTS OF REPAIRING, REPLACING, INTEGRATING, INSTALLING OR RECOVERING SUCH HARDWARE, SOFTWARE, OR DATA.

Any disputes arising between manufacturer and customer shall be governed by the laws of Santa Clara County in the State of California, USA. The State of California, County of Santa Clara shall be the exclusive venue for the resolution of any such disputes. Super Micro's total liability for all claims will not exceed the price paid for the hardware product.

FCC Statement: This equipment has been tested and found to comply with the limits for a Class A digital device pursuant to Part 15 of the FCC Rules. These limits are designed to provide reasonable protection against harmful interference when the equipment is operated in a commercial environment. This equipment generates, uses, and can radiate radio frequency energy and, if not installed and used in accordance with the manufacturer's instruction manual, may cause harmful interference with radio communications. Operation of this equipment in a residential area is likely to cause harmful interference, in which case you will be required to correct the interference at your own expense.

California Best Management Practices Regulations for Perchlorate Materials: This Perchlorate warning applies only to products containing CR (Manganese Dioxide) Lithium coin cells. "Perchlorate Material-special handling may apply. See www.dtsc.ca.gov/hazardouswaste/perchlorate"

WARNING: Handling of lead solder materials used in this product may expose you to lead, a chemical known to the State of California to cause birth defects and other reproductive harm.

Manual Revision 1.2a

Release Date: Sept. 23, 2011

Unless you request and receive written permission from Super Micro Computer, Inc., you may not copy any part of this document.

Information in this document is subject to change without notice. Other products and companies referred to herein are trademarks or registered trademarks of their respective companies or mark holders.

Copyright © 2011 by Super Micro Computer, Inc.
All rights reserved.

Printed in the United States of America

Preface

About this Manual

This manual is written for system integrators, PC technicians and knowledgeable PC users. It provides information for the installation and use of the **SUPER** X8DTL-3/X8DTL-i/X8DTL-3F/X8DTL-iF motherboard.

About this Motherboard

The **SUPER** X8DTL-3/X8DTL-i/X8DTL-3F/X8DTL-iF supports the Intel® 5500/5600 Series Processor, the first dual-processing platform that supports the Intel Quick-Path Interconnect (QPI) Technology, providing the next generation point-to-point system interface to replace the current Front Side Bus. With the Intel 5500/5600 Series Processor built in, the X8DTL-3/X8DTL-i/X8DTL-3F/X8DTL-iF substantially enhances system performance with increased bandwidth and unprecedented scalability optimized for high-end HCP/Cluster systems and intensive applications. Please refer to our web site (<http://www.supermicro.com/products/>) for updates on processor and memory support. This product is intended to be installed and serviced by professional technicians.

Manual Organization

Chapter 1 describes the features, specifications and performance of the motherboard and provides detailed information about the chipset.

Chapter 2 provides hardware installation instructions. Read this chapter when installing the processor, memory modules and other hardware components into the system. If you encounter any problems, see **Chapter 3**, which describes troubleshooting procedures for video, memory and system setup stored in the CMOS.

Chapter 4 includes an introduction to the BIOS and provides detailed information on running the CMOS Setup utility.

Appendix A lists BIOS POST Error Codes. **Appendix B** provides Software Installation Instructions.

Conventions Used in the Manual

Special attention should be given to the following symbols for proper installation and to prevent damage done to the components or injury to yourself:



Danger/Caution: Instructions to be strictly followed to prevent catastrophic system failure or to avoid bodily injury.



Warning: Important information given to ensure proper system installation or to prevent damage to the components.



Note: Additional Information given to differentiate various models or to ensure correct system setup.

Contacting Supermicro

Headquarters

Address: Super Micro Computer, Inc.
980 Rock Ave.
San Jose, CA 95131 U.S.A.

Tel: +1 (408) 503-8000

Fax: +1 (408) 503-8008

Email: marketing@supermicro.com (General Information)
support@supermicro.com (Technical Support)

Web Site: www.supermicro.com

Europe

Address: Super Micro Computer B.V.
Het Sterrenbeeld 28, 5215 ML
's-Hertogenbosch, The Netherlands

Tel: +31 (0) 73-6400390

Fax: +31 (0) 73-6416525

Email: sales@supermicro.nl (General Information)
support@supermicro.nl (Technical Support)
rma@supermicro.nl (Customer Support)

Asia-Pacific

Address: Super Micro Computer, Inc.
4F, No. 232-1, Liancheng Rd.
Chung-Ho 235, Taipei County
Taiwan, R.O.C.

Tel: +886-(2) 8226-3990

Fax: +886-(2) 8226-3991

Web Site: www.supermicro.com.tw

Email: support@supermicro.com.tw (Technical Support)

Tel: +886-(2) 8226-5990 (Technical Support)

Table of Contents

Preface

Chapter 1 Introduction

1-1	Overview	1-1
1-2	Chipset Overview	1-9
1-3	Special Features	1-10
1-4	PC Health Monitoring.....	1-10
1-5	ACPI Features.....	1-11
1-6	Power Supply	1-12
1-7	Super I/O.....	1-12
1-8	Overview of the Nuvoton WPCM450R Controller (For X8DTL-3F/X8DTL-iF Only)	1-13

Chapter 2 Installation

2-1	Static-Sensitive Devices.....	2-1
2-2	Motherboard Installation.....	2-2
2-3	Processor and Heatsink Installation.....	2-3
2-4	Installing and Removing the Memory Modules.....	2-7
2-5	Control Panel Connectors/IO Ports.....	2-11
	1. Back Panel Connectors/IO Ports.....	2-11
	ATX PS/2 Keyboard and PS/2 Mouse Ports.....	2-12
	Universal Serial Bus (USB).....	2-13
	Serial Ports.....	2-14
	Video Connector.....	2-14
	Ethernet Ports	2-15
	2. Front Control Panel.....	2-16
	3. Front Control Panel Pin Definitions	2-17
	NMI Button	2-17
	Power LED	2-17
	HDD LED.....	2-18
	NIC1/NIC2 LED Indicators	2-18
	Overheat (OH)/Fan Fail/PWR Fail/UID LED	2-19
	Power Fail LED	2-19
	Reset Button	2-20
	Power Button	2-20
2-6	Connecting Cables.....	2-21
	Power Connectors	2-21
	Fan Headers.....	2-22
	Chassis Intrusion	2-22

	Internal Speaker	2-23
	Power LED/Speaker	2-23
	Wake-On-LAN	2-24
	Overheat LED/Fan Fail (JOH1).....	2-24
	T-SGPIO 1/2 & 3-SGPIO 1/2 Headers.....	2-25
	I-Button (For X8DTL-3/3F only).....	2-25
	Power SMB (I ² C) Connector	2-26
	IPMB.....	2-26
	Unit Identification Switch/LEDs	2-27
	DOM Power Connector	2-27
	Wake-On-Ring.....	2-28
2-7	Jumper Settings	2-29
	Explanation of Jumpers	2-29
	GLAN Enable/Disable	2-29
	CMOS Clear	2-30
	Watch Dog Enable/Disable	2-30
	I ² C Bus to PCI-Exp. Slots	2-31
	VGA Enable.....	2-31
	SAS Enable/Disable (X8DTL-3/X8DTL-3F only).....	2-32
	SAS RAID Mode Select (X8DTL-3/X8DTL-3F only).....	2-32
2-8	Onboard LED Indicators	2-33
	GLAN LEDs.....	2-33
	IPMI Dedicated LAN LEDs (X8DTL-iF/-3F)	2-33
	SAS Heartbeat LED (X8DTL-3/-3F)	2-34
	BMC Heartbeat LED (X8DTL-iF/3F)	2-34
	Onboard Power LED	2-35
	Rear UID LED	2-35
2-9	Serial ATA and SAS Connections	2-36
	Serial ATA Ports.....	2-36
	SAS Ports (X8DTL-3/X8DTL-3F only).....	2-36
Chapter 3 Troubleshooting		
3-1	Troubleshooting Procedures	3-1
	Before Power On	3-1
	No Power	3-1
	No Video	3-1
	Losing the System's Setup Configuration.....	3-2
	Memory Errors	3-2
3-2	Technical Support Procedures	3-2
3-3	Frequently Asked Questions	3-3

3-4 Returning Merchandise for Service..... 3-4

Chapter 4 BIOS

4-1 Introduction..... 4-1
Starting BIOS Setup Utility..... 4-1
How To Change the Configuration Data 4-1
Starting the Setup Utility 4-2
4-2 Main Setup 4-2
4-3 Advanced Setup Configurations..... 4-4
Power Configuration..... 4-5
4-4 Security Settings 4-24
4-5 Boot Configuration 4-25
4-6 Exit Options..... 4-27

Appendix A BIOS Error Beep Codes

Appendix B Software Installation Instructions

B-1 Installing Software Programs..... B-1
B-2 Configuring Supero Doctor III B-2

Chapter 1

Introduction

1-1 Overview

Checklist

Congratulations on purchasing your computer motherboard from an acknowledged leader in the industry. Supermicro boards are designed with the utmost attention to detail to provide the highest standards in quality and performance. Check that the following items have all been included with your motherboard. If anything listed here is damaged or missing, contact your retailer.

The following items are included in the retail box.

- One (1) Supermicro Mainboard
- Eight (8) Serial ATA cables (CBL-0044L) (For X8DTL-3/X8DTL-3F)
- Six (6) Serial ATA cables (CBL-0044L) (For X8DTL-i/X8DTL-iF)
- One (1) I/O backpanel shield (CSE-PT7L) (X8DTL-3/i)
- One (1) I/O backpanel shield (MCP-260-00027-0N) (X8DTL-3F/iF)
- One (1) Supermicro CD containing drivers and utilities
- One (1) User's/BIOS Manual

SUPER[®] X8DTL-3/X8DTL-i/X8DTL-3F/X8DTL-iF Image

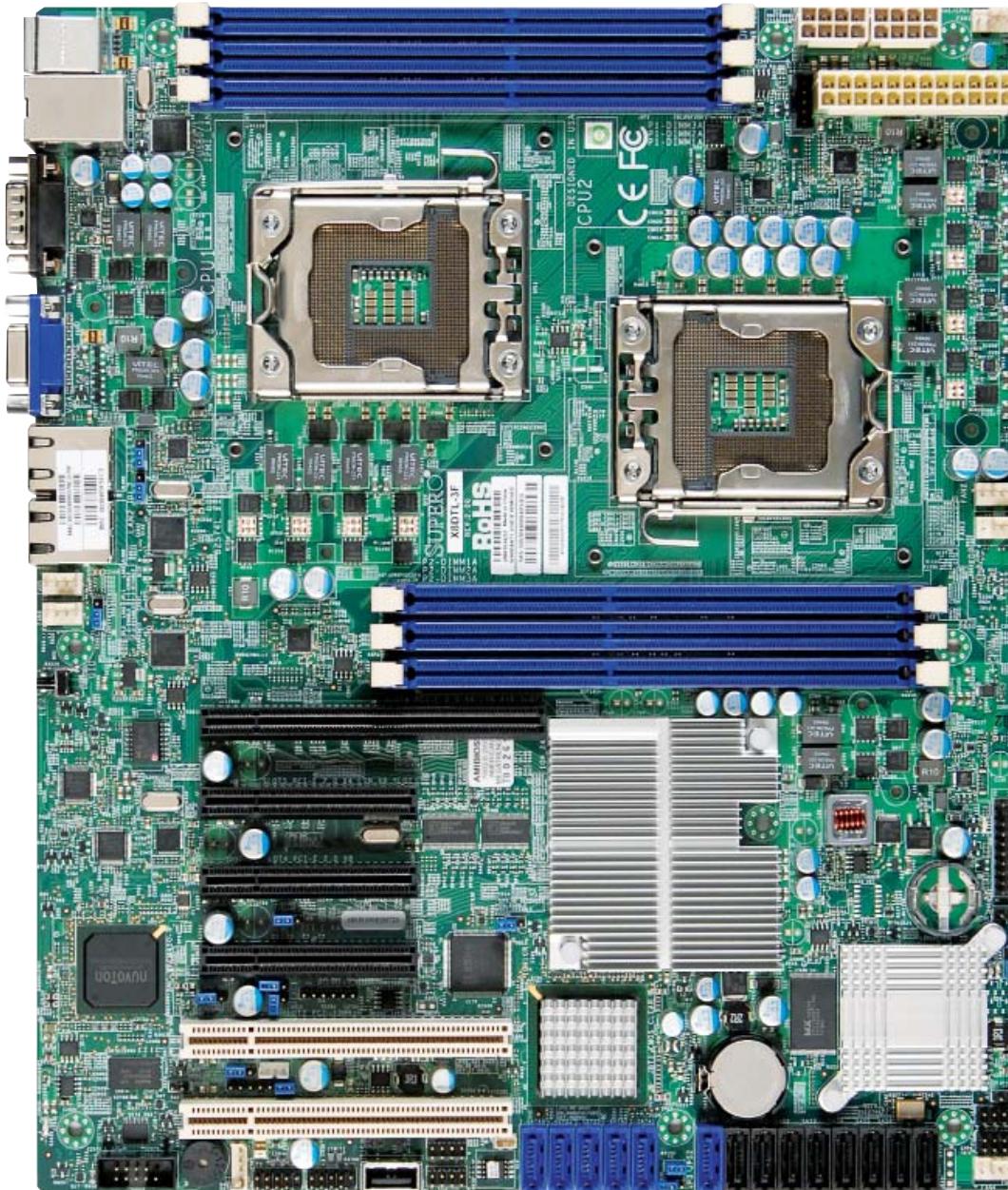

 **Note:** The drawings and pictures shown in this manual were based on the latest PCB Revision available at the time of publishing of the manual. The motherboard you've received may or may not look exactly the same as the graphics shown in the manual. Refer to the table below for the differences between the models.

Differences between X8DTL-3/X8DTL-i/X8DTL-3F/ X8DTL-iF

	X8DTL-3	X8DTL-i	X8DTL-3F	X8DTL-iF
SATA (ICH10R)	Yes	Yes	Yes	Yes
SAS (1068E)	Yes	No	Yes	No
3-SGPIO 1/2	Yes	No	Yes	No
I-Button	Yes	No	Yes	No
IPMI 2.0 w/KVM	No	No	Yes	Yes

SUPER[®] X8DTL-3/X8DTL-i/X8DTL-3F/X8DTL-iF Layout

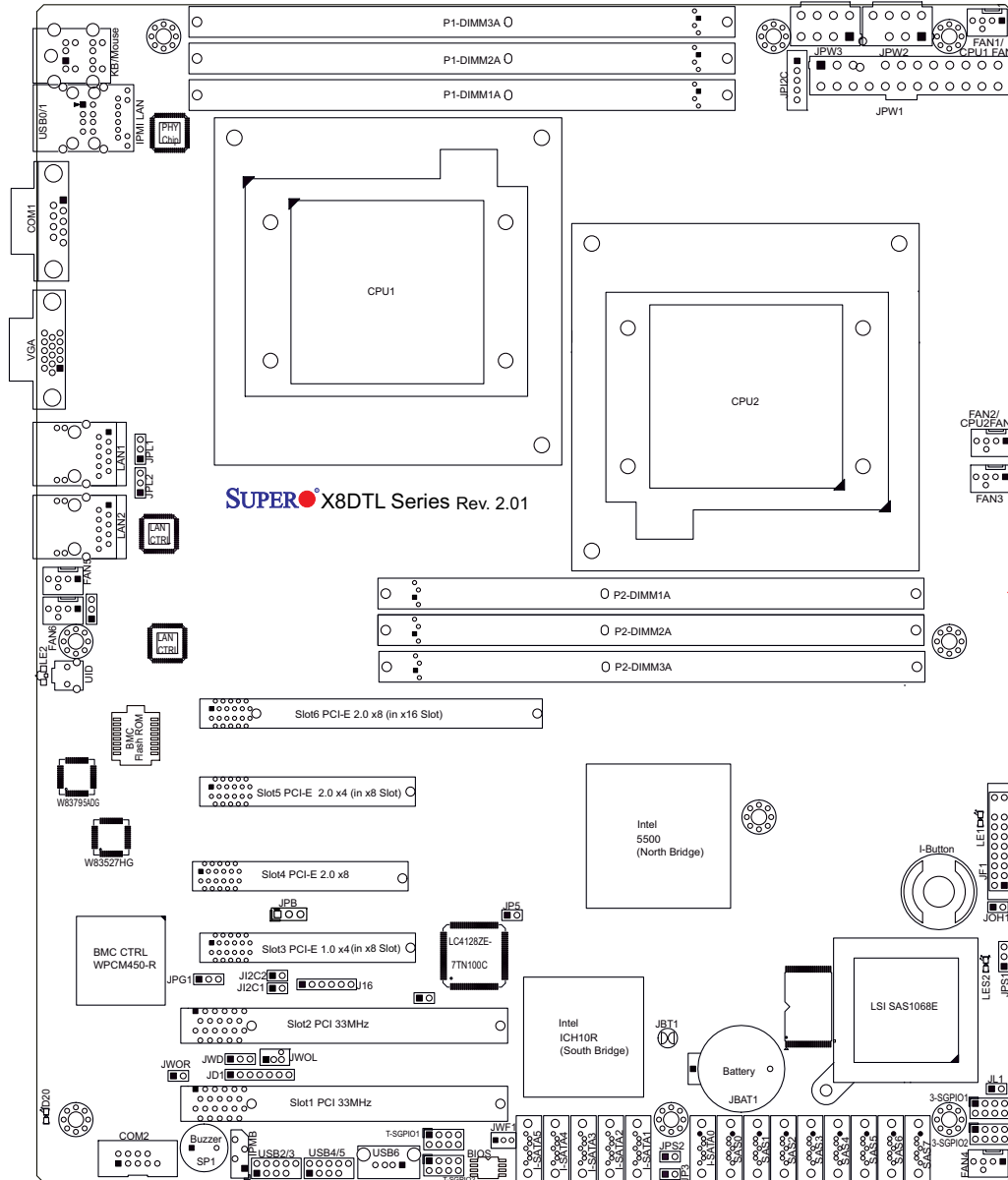

Notes

1. The DOM Power connector (JWF1) and the Wake-On-Ring header (JWOR), are supported by the PCB Rev. 2.01 or a newer version board only.
2. SAS Ports, SAS jumpers, the I-Button, and the LSI 1068E chip are available on the X8DTL-3/-3F only. For SAS RAID configuration, refer to the LSI User Guide posted at our website at <http://www.supermicro.com/support/manuals/>
3. IPMI 2.0, the PHY chip, and the Dedicated LAN (w/KVM support) are available on the X8DTL-3F/-iF only. For more information, refer to the IPMI user guide posted on our website at <http://www.supermicro.com/support/manuals/>.

Quick Reference

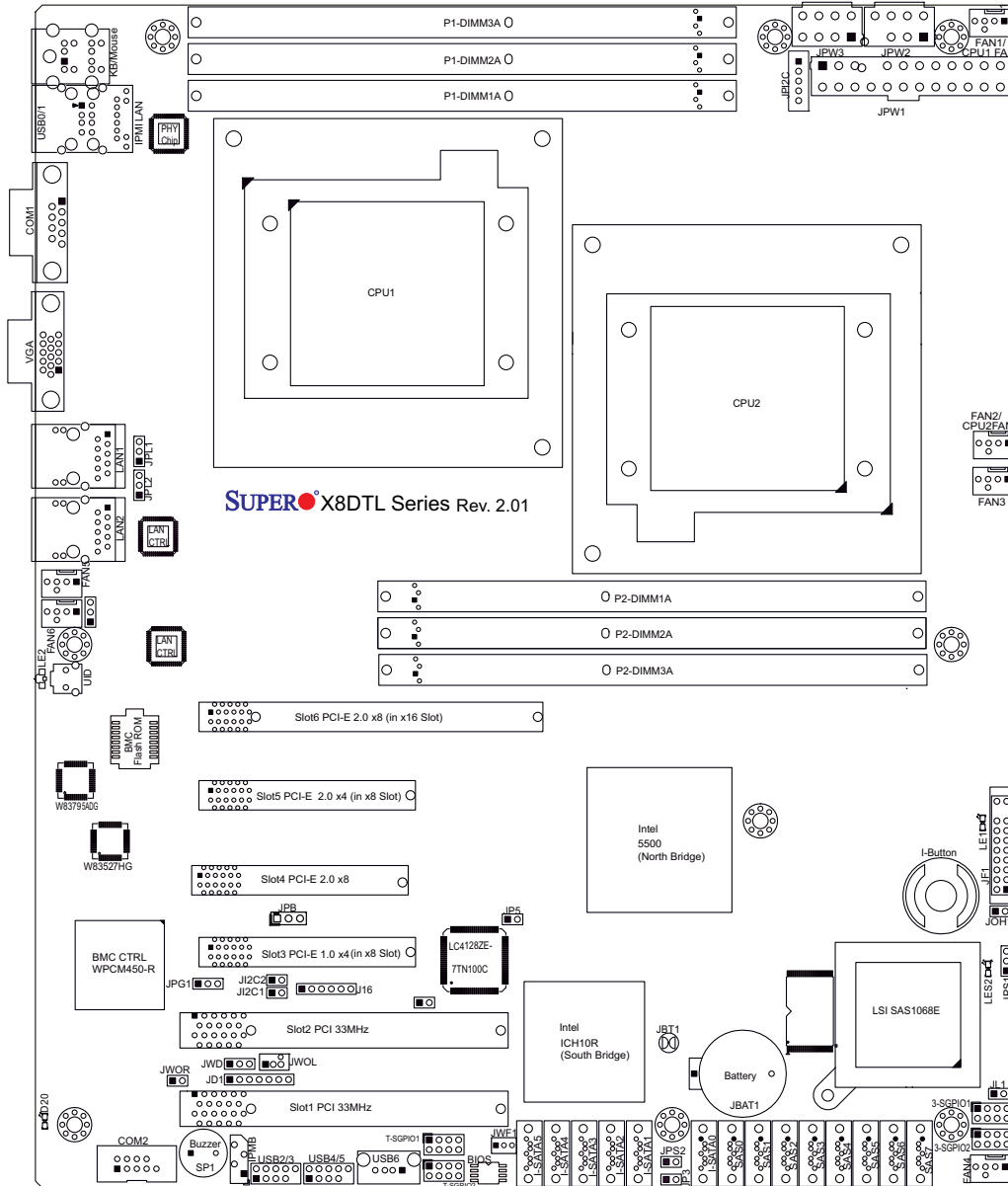

Notes

- Jumpers not indicated are for test purposes only.
- "■" indicates the location of Pin 1.
- When LE1 is on, the onboard power connection is on. Make sure to unplug the power cables before removing or installing components.



Warning! 1. To prevent damage to the power supply or motherboard, please use a power supply that contains a 24-pin and two 8-pin power connectors. Be sure to connect these connectors to the 24-pin (JPW1) and the two 8-pin (JPW2, JPW3) power connectors on the motherboard. Failure in doing so will void the manufacturer warranty on your power supply and motherboard. 2. To avoid possible system overheating, be sure to provide adequate airflow to the system.

X8DTL-3/X8DTL-3F/ X8DTL-i/ X8DTL-iF Quick Reference

Jumper	Description	Default Setting
JBT1	CMOS Clear	Open (Normal)
JI ² C1/JI ² C2	SMB to PCI/PCI-E Slots	Open/Open (Disabled)
JPG1	VGA Enabled	Pins 1-2 (Enabled)
JPL1/JPL2	LAN1/2 Enable	Pins 1-2 (Enabled)
JPS1	SAS Enable	Pins 1-2 (Enabled) (X8DTL-3/3F)
JPS2	SAS RAID Select	Closed (SR RAID Enabled) (X8DTL-3/3F)
JWD	Watch Dog	Pins 1-2 (Reset)

Connector	Description
COM1/COM2	COM1/COM2 Serial Port/Header
FAN 1-6	System/CPU Fan Headers (Fans 1~2: CPU Fans)
I-Button	I-Button for RAID data storage (for X8DTL-3/3F only)
IPMB	IPMB I ² C Header (for an IPMI card) (for X8DTL-iF/3F only)
JPI ² C	Power Supply SMBbus I ² C Header
JD1	PWR LED/Speaker Header (Pins 4~7: Speaker)
JF1	Front Panel Connector
JL1	Chassis Intrusion Header
JOH1	Overheat LED Header
JPW1, JPW2/JPW3	24-pin ATX PWR, 8-pin Secondary PWR (*Warning P. 1-4)
JWF1	DOM (Disk-On-Module) Power Connector (Note 1 on P.1-3.)
JWOL	Wake-On-LAN Header
JWOR	Wake-On-Ring Header (See Note 1 on P. 1-3.)
LAN1/2, Dedicated LAN	G-LAN (RJ45) Ports (Dedicated LAN: X8DTL-iF/3F)
I-SATA0 ~ I-SATA5	(Intel South Bridge) SATA Ports
SAS 0~7	SAS Ports 0~7 (for X8DTL-3/-3F only)
SP1	Internal Buzzer
3-SGPIO-1/3-SGPIO-2	Serial General Purpose I/O Headers for SAS (X8DTL-3/3F)
T-SGPIO-1/T-SGPIO-2	Serial General Purpose I/O Headers for SATA
USB 0/1, 2/3, 4/5, 6	Universal Serial Bus (USB) Ports
UID	Rear Unit Identify Switch
VGA	VGA Connector
LED	Description
D20	BMC Heartbeat LED Indicator
LE1	Onboard Standby LED Indicator
LE2	Rear UID LED
LES2	SAS Heartbeat LED

Motherboard Features

CPU

- Two Intel® 5500/5600* Series (LGA 1366) processors, each processor supporting two full-width Intel QuickPath Interconnect (QPI) @6.4 GT/s with a total of up to 51.2 GB/s Data Transfer Rate (6.4 GB/s per direction) (*Note 1 on P. 1-3.)

Memory

- Six 240-pin DIMM sockets support up to 96 GB Reg. ECC or 24 GB Unbuffered ECC/Non-ECC DDR3 1333 MHz/1066 MHz/ 800 MHz Memory modules (See Section 2-4 in Chapter 2 for DIMM Slot Population.)

Chipset

- Intel 5500 chipset, including: the 5500 (IOH-24D) and the ICH10R (South Bridge).

Expansion Slots

- One PCI-E 2.0 x8 (in x16) slot (Slot 6)
- One PCI-E 2.0 x8 slot (Slot 4)
- One PCI-E 2.0 x4 (in x8) slot (Slot 5)
- One PCI-E 1.0 x4 (in x8) (Slot 3)
- Two 32-bit PCI 33 slot (Slot 1 and Slot 2)

BIOS

- 32 Mb AMI SPI Flash ROM
- PCI 2.2, ACPI 1.0/2.0/3.0, Plug and Play (PnP), DMI 2.3, USB Keyboard support, and SMBIOS 2.3

PC Health Monitoring

- Onboard voltage monitors for CPU1 Vcore, CPU2 Vcore, CPU2 DIMM, CPU1 DIMM, 5V, 5VSB, 12V, -12V, 3.3Vcc, 3.3VSB, VBAT and Vtt.
- Fan status monitor with firmware control and CPU fan auto-off in sleep mode
- Platform Environment Control Interface (PECI) ready and Thermal Monitor 2 (TM2) support
- CPU/chassis temperature monitors and CPU slow-down on overheat
- Pulse Width Modulation (PWM) Fan Control
- CPU thermal trip support for processor protection, power LED
- Power-up mode control for recovery from AC power loss
- Auto-switching voltage regulator for CPU cores
- System overheat/Fan Fail LED Indicator and control
- Chassis intrusion detection
- System resource alert via Supero Doctor III

ACPI Features

- Slow blinking LED for suspend state indicator
- Main switch override mechanism
- ACPI Power Management
- Keyboard Wakeup from Soft-off

Onboard I/O

- Intel ICH10R supports six SATA2 ports (with RAID0, RAID1, RAID10, RAID5 supported in the Windows OS and RAID0, RAID1, RAID10 in the Linux platforms) (**Note 1**)
- LSI 1068E supports eight SAS ports support RAID0, RAID1, RAID10, and optional RAID5 w/I-Button 68 (For X8DTL-3/-3F) (**Note 2**)
- Dual 82574L Gigabit Ethernet controllers support Gigabit LAN1/2 ports
- A PHY chip supports the Dedicated IPMI LAN (X8DTL-iF/3F only) (Note 3)
- One VGA Port supported by the Winbond G200EW
- Two COM ports(1 header, 1 port)
- PS/2 mouse and PS/2 keyboard ports
- Up to seven USB 2.0 (Universal Serial Bus) (2 Backpanel USB Ports, 1 Front USB Header, and 2 Type A Headers)
- Super I/O: Winbond W83627DHG-P
- IPMI 1.5/2.0 with full KVM support (X8DTL-3F/iF only) (**Note 3**)

Other

- Wake-on-LAN (WOL) and Wake-on-Ring (WOR)
- Console redirection
- Onboard Fan Speed Control by Thermal Management via BIOS

CD/Diskette Utilities

- BIOS flash upgrade utility and device drivers

Dimensions

- Ext. ATX 12.00" (L) x 10.00" (W) (304.80 mm x 254.20 mm)



Note 1: For more information on SATA HostRAID configuration, please refer to the Intel SATA HostRAID User's Guide posted on our website @ <http://www.supermicro.com/support/manuals/>.

Note 2: For more information on LSI SAS RAID configuration, please refer to the LSI MegaRAID User's Guide posted on our website @ <http://www.supermicro.com/support/manuals/>.

Note 3: For more information on IPMI configuration, please refer to the Embedded IPMI User's Guide posted on our website @ <http://www.supermicro.com/support/manuals/>.

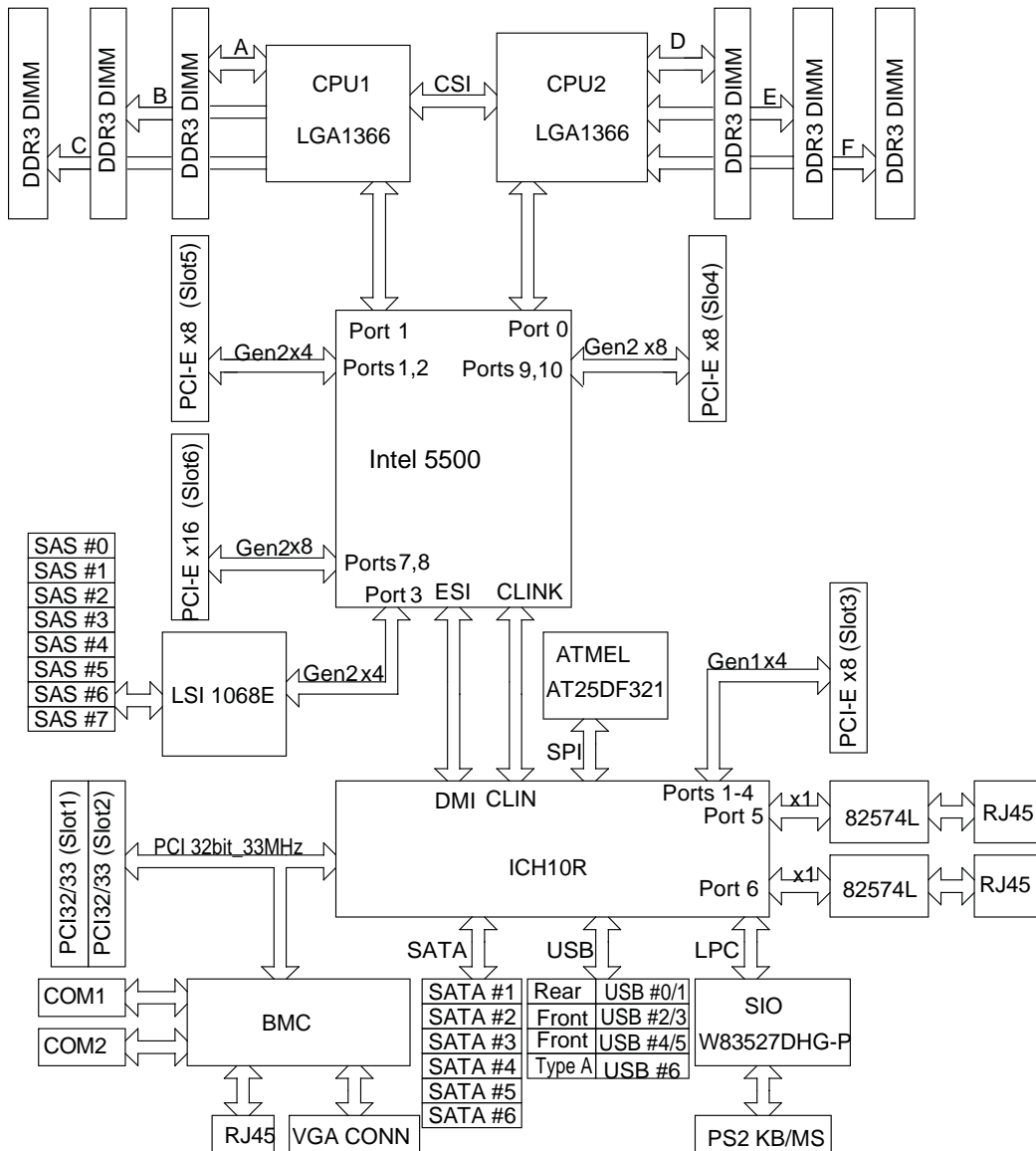

Block Diagram of the 5500 Chipset

 **Note:** This is a general block diagram. Please see the previous Motherboard Features pages for details on the features of each motherboard.

1-2 Chipset Overview

Built upon the functionality and the capability of the 5500 platform, the X8DTL-3/X8DTL-i/X8DTL-3F/X8DTL-iF motherboard provides the performance and feature set required for dual-processor-based high-end systems with configuration optimized for HCP/Cluster systems and intensive applications. The 5500 platform consists of the 5500/5600 Series (LGA 1366) processor, the IOH-24D (I/O Hub), and the ICH10R (South Bridge). With the Intel QuickPath Interconnect (QPI) controller built in, the 5500 platform is the first dual-processing platform that offers the next generation point-to-point system interconnect interface, replacing the current Front Side Bus Technology, substantially enhancing system performance with increased bandwidth and scalability.

The IOH-24D connects to each processor through an independent QuickPath Interconnect (QPI) link. Each link consists of 20 pairs of unidirectional differential lanes for transmission and receiving in addition to a differential forwarded clock. A full-width QPI link pair provides 84 signals. Each processor supports two QuickPath links, one going to the other processor and the other to the IOH-24D chip.

The 5500 Platform supports PCI Express Gen2 lanes, peer-to-peer read and write transactions. The ICH10R provides up to 6 PCI-Express ports, six SATA ports and 10 USB connections.

In addition, the 5500 platform also offers a wide range of RAS (Reliability, Availability and Serviceability) features. These features include memory interface ECC, x4/x8 Single Device Data Correction (SDDC), Cyclic Redundancy Check (CRC), parity protection, out-of-band register access via SMBus, memory mirroring, and Hot-plug support on the PCI-Express Interface.

Main Features of the 5500/5600* Series Processor and the 5500 Chipset

- Four processor cores in each processor with 8MB shared cache among cores
- Two full-width Intel QuickPath interconnect links, up to 6.4 GT/s of data transfer rate in each direction
- Virtualization Technology, Integrated Management Engine supported
- Point-to-point cache coherent interconnect, Fast/narrow unidirectional links, and Concurrent bi-directional traffic
- Error detection via CRC and Error correction via Link level retry

1-3 Special Features

Recovery from AC Power Loss

BIOS provides a setting for you to determine how the system will respond when AC power is lost and then restored to the system. You can choose for the system to remain powered off (in which case you must hit the power switch to turn it back on) or for it to automatically return to a power-on state. See the Advanced BIOS Setup section to change this setting. The default setting is **Last State**.

1-4 PC Health Monitoring

This section describes the PC health monitoring features of the X8DTL-3/X8DTL-i/X8DTL-3F/X8DTL-iF. All have an onboard System Hardware Monitor chip that supports PC health monitoring. An onboard voltage monitor will scan these onboard voltages continuously: CPU1 Vcore, CPU2 Vcore, CPU2 DIMM, CPU1 DIMM, 5V, 5VSB, 12V, -12V, 3.3Vcc, 3.3VSB, VBAT and Vtt. Once a voltage becomes unstable, a warning is given or an error message is sent to the screen. Users can adjust the voltage thresholds to define the sensitivity of the voltage monitor.

Fan Status Monitor with Firmware Control

The PC health monitor can check the RPM status of the cooling fans. The onboard CPU and chassis fans are controlled by Thermal Management via BIOS (under Hardware Monitoring in the Advanced Setting).

Environmental Temperature Control

The thermal control sensor monitors the CPU temperature in real time and will turn on the thermal control fan whenever the CPU temperature exceeds a user-defined threshold. The overheat circuitry runs independently from the CPU. Once it detects that the CPU temperature is too high, it will automatically turn on the thermal fan control to prevent any overheat damage to the CPU. The onboard chassis thermal circuitry can monitor the overall system temperature and alert users when the chassis temperature is too high.



Warning! To avoid possible system overheating, be sure to provide adequate airflow to the system.

System Resource Alert

This feature is available when used with Supero Doctor III in the Windows OS environment or used with Supero Doctor II in Linux. Supero Doctor is used to

notify the user of certain system events. For example, you can also configure Supero Doctor to provide you with warnings when the system temperature, CPU temperatures, voltages and fan speeds go beyond a pre-defined range.

1-5 ACPI Features

ACPI stands for Advanced Configuration and Power Interface. The ACPI specification defines a flexible and abstract hardware interface that provides a standard way to integrate power management features throughout a PC system, including its hardware, operating system and application software. This enables the system to automatically turn on and off peripherals such as CD-ROMs, network cards, hard disk drives and printers.

In addition to enabling operating system-directed power management, ACPI provides a generic system event mechanism for Plug and Play and an operating system-independent interface for configuration control. ACPI leverages the Plug and Play BIOS data structures while providing a processor architecture-independent implementation that is compatible with Windows XP, Windows 2003, Windows 2008 and Windows Vista Operating Systems.

Slow Blinking LED for Suspend-State Indicator

When the CPU goes into a suspend state, the chassis power LED will start blinking to indicate that the CPU is in suspend mode. When the user presses any key, the CPU will wake-up and the LED will automatically stop blinking and remain on.

Main Switch Override Mechanism

When an ATX power supply is used, the power button can function as a system suspend button to make the system enter a SoftOff state. The monitor will be suspended and the hard drive will spin down. Pressing the power button again will cause the whole system to wake-up. During the SoftOff state, the ATX power supply provides power to keep the required circuitry in the system "alive." In case the system malfunctions and you want to turn off the power, just press and hold the power button for 4 seconds. This option can be set in the Power section of the BIOS Setup routine.

Wake-On-LAN (WOL)

Wake-On-LAN is defined as the ability of a management application to remotely power up a computer that is powered off. Remote PC setup, up-dates and asset tracking can occur after hours and on weekends so that daily LAN traffic is kept to a minimum and users are not interrupted. The motherboard has a 3-pin header (WOL) to connect to the 3-pin header on a Network Interface Card (NIC) that has

WOL capability. In addition, an onboard LAN controller can also support WOL without any connection to the WOL header. The 3-pin WOL header is to be used with a LAN add-on card only.



Note: Wake-On-LAN requires an ATX 2.01 (or above) compliant power supply.

External Modem Ring-On

Wake-up events can be triggered by a device such as the external modem ringing when the system is in the SoftOff state. Note that external modem ring-on can only be used with an ATX 2.01 (or above) compliant power supply.

1-6 Power Supply

As with all computer products, a stable power source is necessary for proper and reliable operation. It is even more important for processors that have high CPU clock rates.

The X8DTL-3/X8DTL-i/X8DTL-3F/X8DTL-iF can accommodate 24-pin ATX power supplies. Although most power supplies generally meet the specifications required by the CPU, some are inadequate. In addition, the two 12V 8-pin power connections are also required to ensure adequate power supply to the system. Also your power supply must supply 1.5A for the Ethernet ports.



Warning: To prevent damage to the power supply or motherboard, please use a power supply that contains a 24-pin and two 8-pin power connectors. Be sure to connect these connectors to the 24-pin (JPW1) and the two 8-pin (JPW2,JPW3) power connectors on the motherboard for adequate power supply to your system. Failure in doing so will void the manufacturer warranty on your power supply and motherboard.

It is strongly recommended that you use a high quality power supply that meets ATX power supply Specification 2.02 or above. It must also be SSI compliant (For more information, please refer to the web site at <http://www.ssiforum.org/>). Additionally, in areas where noisy power transmission is present, you may choose to install a line filter to shield the computer from noise. It is recommended that you also install a power surge protector to help avoid problems caused by power surges.

1-7 Super I/O

The Super I/O supports 360 K, 720 K, 1.2 M, 1.44 M or 2.88 M disk drives and data transfer rates of 250 Kb/s, 500 Kb/s or 1 Mb/s. It also provides two high-speed, 16550 compatible serial communication ports (UARTs). Each UART includes a 16-byte send/receive FIFO, a programmable baud rate generator, complete modem

control capability and a processor interrupt system. Both UARTs provide legacy speed with baud rate of up to 115.2 Kbps as well as an advanced speed with baud rates of 250 K, 500 K, or 1 Mb/s, which support higher speed modems.

The Super I/O provides functions that comply with ACPI (Advanced Configuration and Power Interface), which includes support of legacy and ACPI power management through an SMI or SCI function pin. It also features auto power management to reduce power consumption.

1-8 Overview of the Nuvoton WPCM450R Controller (For X8DTL-3F/X8DTL-iF Only)

The Nuvoton WPCM450R Controller is a Baseboard Management Controller (BMC) that supports the 2D/VGA-compatible Graphics Core with the PCI interface, Virtual Media, and Keyboard/Video/Mouse Redirection (KVMR) modules. With blade-oriented Super I/O capability built-in, the WPCM450R Controller is ideal for legacy-reduced server platforms.

The WPCM450R interfaces with the host system via a PCI interface to communicate with the Graphics core. It supports USB 2.0 and 1.1 for remote keyboard/mouse/virtual media emulation. It also provides LPC interface to control Super IO functions. The WPCM450R is connected to the network via an external Ethernet PHY module.

The WPCM450R communicates with onboard components via six SMBus interfaces, fan control, and Platform Environment Control Interface (PECI) buses.



Note: For more information on IPMI configuration, please refer to the IPMI user guide posted on our website @ <http://www.supermicro.com/support/manuals/>

Notes

Chapter 2

Installation

2-1 Static-Sensitive Devices

Electrostatic Discharge (ESD) can damage electronic components. To prevent damage to your system board, it is important to handle it very carefully. The following measures are generally sufficient to protect your equipment from ESD.

Precautions

- Use a grounded wrist strap designed to prevent static discharge.
- Touch a grounded metal object before removing the board from the antistatic bag.
- Handle the board by its edges only; do not touch its components, peripheral chips, memory modules or gold contacts.
- When handling chips or modules, avoid touching their pins.
- Put the motherboard and peripherals back into their antistatic bags when not in use.
- For grounding purposes, make sure your computer chassis provides excellent conductivity between the power supply, the case, the mounting fasteners and the motherboard.
- Use only the correct type of onboard CMOS battery as specified by the manufacturer. Do not install the onboard battery upside down to avoid possible explosion.

Unpacking

The motherboard is shipped in antistatic packaging to avoid static damage. When unpacking the board, make sure the person handling it is static protected.

2-2 Motherboard Installation

All motherboards have standard mounting holes to fit different types of chassis. Make sure that the locations of all the mounting holes for both motherboard and chassis match. Although a chassis may have both plastic and metal mounting fasteners, metal ones are highly recommended because they ground the motherboard to the chassis. Make sure that the metal standoffs click in or are screwed in tightly. Then use a screwdriver to secure the motherboard onto the motherboard tray. Note: Some components are very close to the mounting holes. Please take precautionary measures to prevent damage to these components when installing the motherboard to the chassis.

Tools Needed

1. Phillips Screwdriver



2. Pan head #6 screws



Installation Instructions

1. Install the IO shield into the chassis.
2. Locate the mounting holes on the motherboard. Refer to the layout above for mounting hole locations.
3. Locate the matching mounting holes on the chassis. Align the mounting holes on the motherboard against the mounting holes on the chassis.
4. Install standoffs in the chassis as needed.
5. Install the motherboard into the chassis carefully to avoid damage to motherboard components.



Warning: To avoid damaging the motherboard and its components, please do not apply any force greater than 8 *lb/sq.in* (8 lbs. per square inch) when installing a screw into a mounting hole.

6. Insert a Pan head #6 screw into a mounting hole on the motherboard and its matching mounting hole on the chassis, using a Phillips screwdriver.
7. Repeat Step 4 to insert #6 screws to all mounting holes.
8. Make sure that the motherboard is securely placed on the chassis.

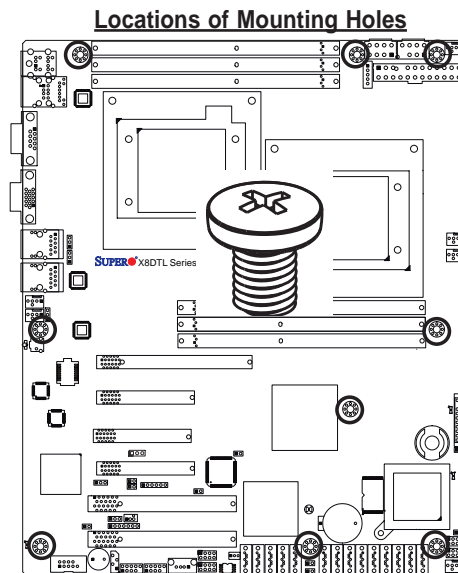

2-3 Processor and Heatsink Installation



When handling the processor package, avoid placing direct pressure on the label area of the fan.

Notes:

1. Always connect the power cord last and always remove it before adding, removing or changing any hardware components. Make sure that you install the processor into the CPU socket before you install the CPU heatsink.
2. Make sure to install the motherboard into the chassis before you install the CPU heatsink and heatsink fans.
3. When purchasing a motherboard without a 5500/5600 Series processor pre-installed, make sure that the CPU socket plastic cap is in place, and none of the CPU socket pins are bent; otherwise, contact the retailer immediately.
4. Refer to the MB Features Section for more details on CPU support.

Installing an LGA 1366 Processor

1. Press the socket clip to release the load plate, which covers the CPU socket, from its locking position.
2. Gently lift the socket clip to open the load plate.
3. Hold the plastic cap at its north and south center edges to remove it from the CPU socket.



Socket Clip **Load Plate**



Plastic Cap



Hold the north & south edges of the plastic cap to remove it

1. After removing the plastic cap, using your thumb and the index finger, hold the CPU at the north and south center edges.
2. Align the CPU key, the semi-circle cutout, against the socket key, the notch below the gold color dot on the side of the socket.
3. Once both the CPU and the socket are aligned, carefully lower the CPU straight down into the socket. (Do not rub the CPU against the surface of the socket or its pins to avoid damaging the CPU or the socket.)
4. With the CPU inside the socket, inspect the four corners of the CPU to make sure that the CPU is properly installed.
5. Once the CPU is securely seated on the socket, lower the CPU load plate to the socket.
6. Use your thumb to gently push the socket clip down to the clip lock.



Warning: Please save the plastic cap. The motherboard must be shipped with the plastic cap properly installed to protect the CPU socket pins. Shipment without the plastic cap properly installed will cause damage to the socket pins.

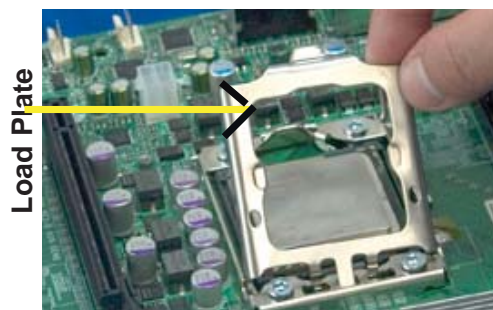
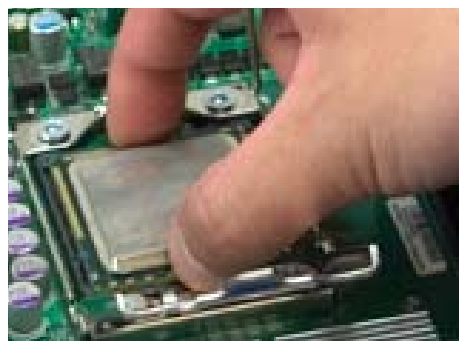
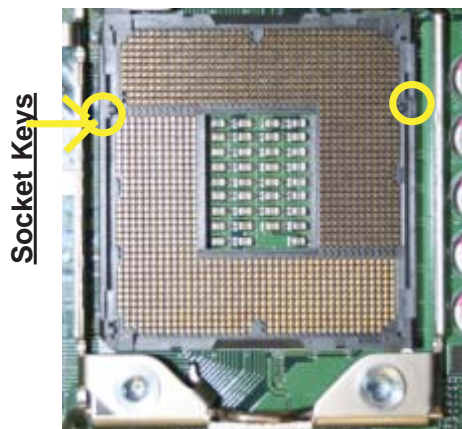
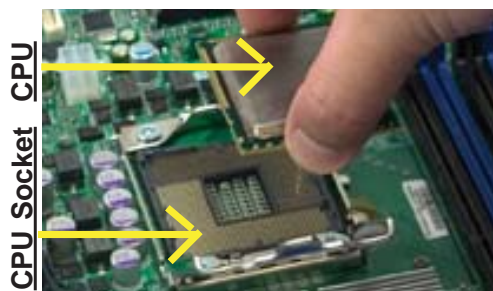

Installing a CPU Heatsink

1. Do not apply any thermal grease to the heatsink or the CPU die because the required amount has already been applied.
2. Place the heatsink on top of the CPU so that the four mounting holes are aligned with those on the retention mechanism.
3. Install two diagonal screws (ie the #1 and the #2 screws) and tighten them until just snug (-do not fully tighten the screws to avoid possible damage to the CPU.)
4. Finish the installation by fully tightening all four screws.

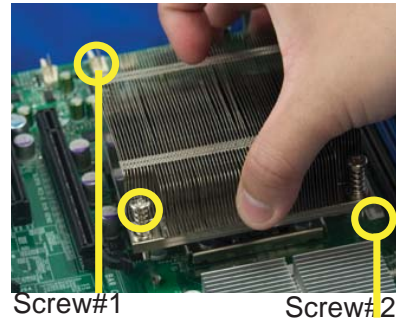
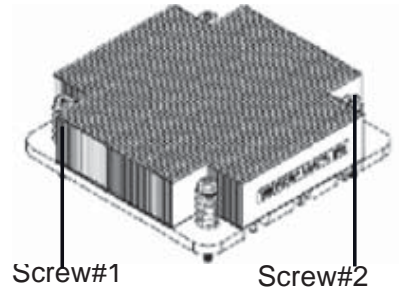

Install Screw#1

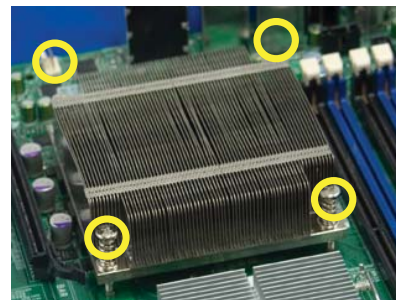
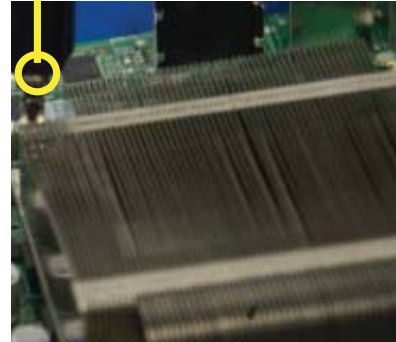

Removing the Heatsink



Warning: We do not recommend that the CPU or the heatsink be removed. However, if you do need to remove the heatsink, please follow the instructions below to uninstall the heatsink and prevent damage to the CPU or other components.

1. Unplug the power cord from the power supply.
2. Disconnect the heatsink fan wires from the CPU fan header.
3. Using a screwdriver, loosen and remove the heatsink screws from the motherboard in the sequence as show in the picture on the right.
4. Hold the heatsink as shown in the picture on the right and gently wriggle the heatsink to loosen it from the CPU. (Do not use excessive force when wriggling the heatsink.)
5. Once the CPU is loosened, remove the heatsink from the CPU socket.
6. To reinstall the CPU and the heatsink, clean the surface of the CPU and the heatsink to get rid of the old thermal grease. Reapply the proper amount of thermal grease on the surface before reinstalling them on the motherboard.

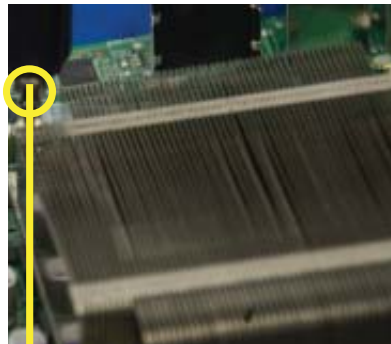

Using a screwdriver to remove Screw#1

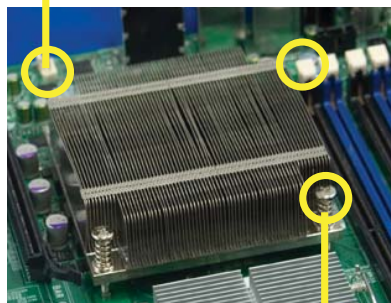

Remove Screw#2



2-4 Installing and Removing the Memory Modules

Note: Check the Supermicro web site for recommended memory modules.



CAUTION

Exercise extreme care when installing or removing DIMM modules to prevent any possible damage.

Installing & Removing DIMMs

1. Insert the desired number of DIMMs into the memory slots, starting with P1-DIMM #1A. When populating multiple DIMM modules within a channel, always start with Bank1 first. (For best performance, please use the memory modules of the same type and same speed in the same bank.)
2. Press down the release tabs on the ends of a memory slot. Insert each DIMM module vertically into its slot. Pay attention to the notch along the bottom of the module to prevent inserting the DIMM module incorrectly.
3. Gently press down on the DIMM module until it snaps into place in the slot. Repeat for all modules.
4. Reverse the steps above to remove the DIMM modules from the motherboard.

Press down the release tabs

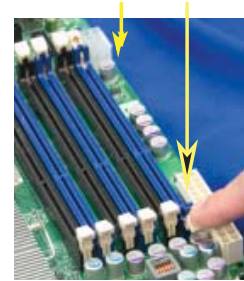

Insert & press down a DIMM module into the slot

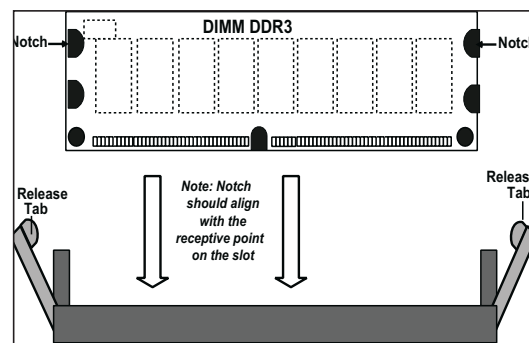
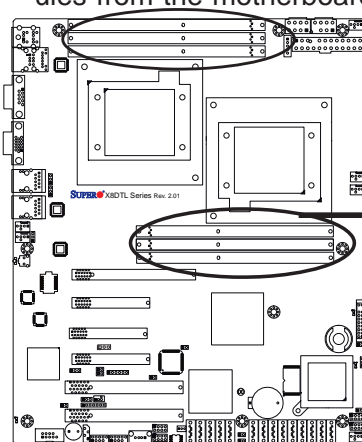
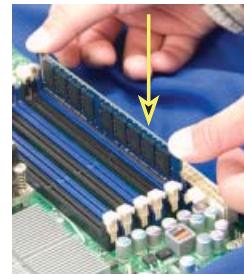

To Install: Insert module vertically and press down until it snaps into place. Pay attention to the alignment notch at the bottom.

To Remove:

Use your thumbs to gently push the release tabs near both ends of the module. This should release it from the slot.

Top View of DDR3 Slot

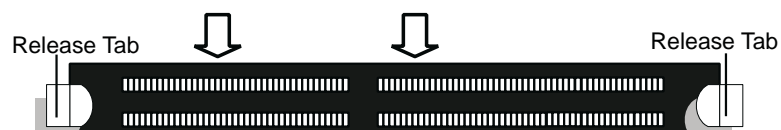

Memory Support

The X8DTL-3/-i/-3F/iF supports up to 96 GB Registered ECC or up to 24 GB Unbuffered ECC/Non-ECC DDR3 1333 MHz/1066 MHz/800 MHz in six DIMMs.

 **Note:** Memory Speed support depends on the type(s) of CPU(s) installed on the motherboard.

DIMM Module Population Configuration

For memory to work properly, follow the tables below for memory installation:

Memory Population for Optimal Performance -For a motherboard with One CPU (CPU1) installed (To Populate P1-DIMM slots)			
	Branch 0	Branch 1	Branch 2
3 DIMMs	P1-1A	P1-2A	P1-3A

Memory Population for Optimal Performance -For a motherboard with One CPU (CPU2) installed (To Populate P2-DIMM slots)			
	Branch 0	Branch 1	Branch 2
3 DIMMs	P2-1A	P2-2A	P2-3A

Memory Population for Optimal Performance -For a motherboard with Two CPUs installed						
	CPU1 (To populate P1-DIMMs)			CPU2 (To populate P2-DIMMs)		
	Branch 0	Branch 1	Branch 2	Branch 0	Branch 1	Branch 2
6 DIMMs	P1-1A	P1-2A	P1-3A	P2-1A	P2-2A	P2-3A

Memory Support for a Motherboard w/ the 5500 Processors Installed

Memory Population Table				
DIMM Slots per Channel	DIMMs Populated per Channel	DIMM Type (Reg.= Registered)	Speeds (in MHz)	Ranks per DIMM (any combination; SR=Single Rank, DR=Dual Rank, QR=Quad Rank)
1	1	Reg. DDR3 ECC	800,1066,1333	SR, DR
1	1	Reg. DDR3 ECC	800,1066	QR

Unbuffered DIMM (UDIMM) Population Table				
DIMM Slots per Channel	DIMMs Populated per Channel	DIMM Type (Unb.= Unbuffered)	Speeds (in MHz)	Ranks per DIMM (SR=Single Rank, DR=Dual Rank, QR=Quad Rank)
1	1	Unb. DDR3 ECC/ Non-ECC	800,1066, 1333	SR or DR

Memory Support for the Motherboard w/5600 Processors Installed

- 1.5V Registered DIMMs (for the PCB R2.01 or a later version board only)

1.5V RDIMM Population for a motherboard w/5600 Processors Installed				
DIMM Slots per Channel	DIMMs Populated per Channel	DIMM Type (Reg.=Registered)	Speeds (in MHz)	Ranks per DIMM (any combination; SR=Single Rank, DR=Dual Rank, QR=Quad Rank)
1	1	Reg. DDR3 ECC	800,1066,1333	SR or DR
1	1	Reg. DDR3 ECC	800,1066	QR

Note 1: 1333 MHz RDIMMs will run at 1066 MHz (-BIOS automatic downgrading).

- 1.5V Unbuffered DIMMs (for the PCB R2.01 or a later version board only)

1.5V UDIMM Population for for a motherboard w/5600 Processors Installed				
DIMM Slots per Channel	DIMMs Populated per Channel	DIMM Type (Unb.=Unbuffered)	Speeds (in MHz)	Ranks per DIMM (any combination; SR=Single Rank, DR=Dual Rank, QR=Quad Rank)
1	1	Unb. DDR3 ECC/Non-ECC	800,1066,1333	SR, DR, Mixing SR, DR

Note 1: Mixing of 1.35V and 1.5V DIMMs is not recommended.

- 1.35V Registered DIMMs (for the PCB R2.01 or a later version board only)

1.35V RDIMM Population a Motherboard w/5600 Processors Installed				
DIMM Slots per Channel	DIMMs Populated per Channel	DIMM Type (Reg.=Registered)	Speeds (in MHz)	Ranks per DIMM (any combination; SR=Single Rank, DR=Dual Rank, QR=Quad Rank)
1	1	Reg. DDR3 ECC	800,1066,1333	SR, DR, Mixing SR, DR
1	1	Reg. DDR3 ECC	800 (Note 1)	QR

Note 1: 1333/1066 MHz QR RDIMMs will run at 800 MHz (-BIOS automatic downgrading).
Note 2: Mixing of 1.35V and 1.5V DIMMs is not recommended.

- 1.35V Unbuffered DIMMs (for the PCB R2.01 or a later version board only)

1.35V UDIMM Population for a motherboard w/5600 Processors Installed				
DIMM Slots per Channel	DIMMs Populated per Channel	DIMM Type (Unb.=Unbuffered)	Speeds (in MHz)	Ranks per DIMM (any combination; SR=Single Rank, DR=Dual Rank, QR=Quad Rank)
1	1	Unb. DDR3 ECC	800,1066,1333	SR or DR

Note 1: 1333 MHz for two DIMMs per channel is supported when Unbuf./ECC DIMMs are used.
Note 2: Mixing of 1.35V and 1.5V DIMMs is not recommended.

 **Note 1:** Due to OS limitations, some operating systems may not show more than 4 GB of memory.

Note 2: Due to memory allocation to system devices, the amount of memory that remains available for operational use will be reduced when 4 GB of RAM is used. The reduction in memory availability is disproportional. (See the following Table.)

Possible System Memory Allocation & Availability		
System Device	Size	Physical Memory Remaining (-Available) (4 GB Total System Memory)
Firmware Hub flash memory (System BIOS)	1 MB	3.99 GB
Local APIC	4 KB	3.99 GB
Area Reserved for the chipset	2 MB	3.99 GB
I/O APIC (4 Kbytes)	4 KB	3.99 GB
PCI Enumeration Area 1	256 MB	3.76 GB
PCI Express (256 MB)	256 MB	3.51 GB
PCI Enumeration Area 2 (if needed) -Aligned on 256-MB boundary-	512 MB	3.01 GB
VGA Memory	16 MB	2.85 GB
TSEG	1 MB	2.84 GB
Memory available for the OS & other applications		2.84 GB

2-5 Control Panel Connectors/I/O Ports

The I/O ports are color coded in conformance with the PC 99 specification. See the picture below for the colors and locations of the various I/O ports.

1. Back Panel Connectors/I/O Ports

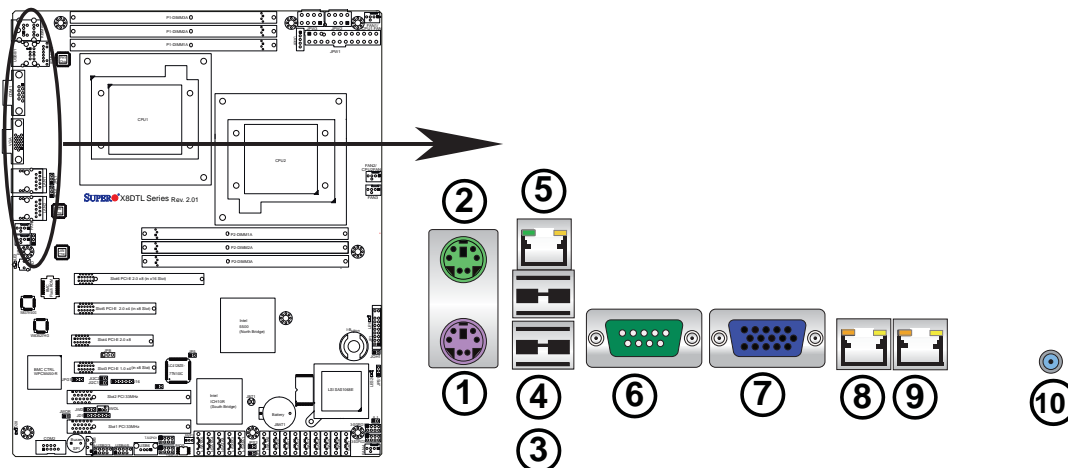

Back Panel I/O Port Locations and Definitions

Back Panel Connectors

1. Keyboard (Purple)
2. PS/2 Mouse (Green)
3. Back Panel USB Port 0
4. Back Panel USB Port 1
5. Dedicated LAN (X8DTL-3F/iF only)
6. COM Port 1 (Turquoise)
7. VGA (Blue)
8. Gigabit LAN 1
9. Gigabit LAN 2
10. UID Switch

ATX PS/2 Keyboard and PS/2 Mouse Ports

The ATX PS/2 keyboard and PS/2 mouse are located next to the Back Panel USB Ports 0~1 on the motherboard. See the table at right for pin definitions.

PS/2 Keyboard/Mouse Pin Definitions			
PS2 Keyboard		PS2 Mouse	
Pin#	Definition	Pin#	Definition
1	KB Data	1	Mouse Data
2	No Connection	2	No Connection
3	Ground	3	Ground
4	Mouse/KB VCC (+5V)	4	Mouse/KB VCC (+5V)
5	KB Clock	5	Mouse Clock
6	No Connection	6	No Connection

VCC: with 1.5A PTC (current limit)

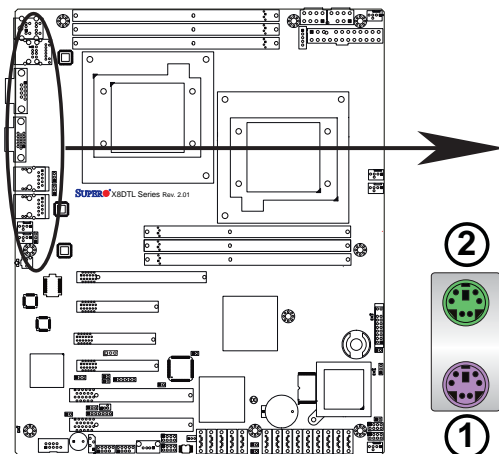

- 1. Keyboard (Purple)
- 2. Mouse (Green)

Universal Serial Bus (USB)

Two Universal Serial Bus ports (USB 0 and USB 1) are located on the I/O back panel. Additionally, five USB connections (USB 2/3, 4/5, 6) are on the motherboard to provide front chassis access. (Cables are not included). See the tables on the right for pin definitions.

Back Panel USB (USB 0/1)	
Pin#	Definitions
1	+5V
2	PO-
3	PO+
4	Ground
5	N/A

Front Panel USB (USB 6)	
Pin#	Definition
1	Vcc
2	Data-
3	Data+
4	Ground
5	NA

Front Panel USB Pin Definitions (USB2/3/4/5)			
USB 2/3		USB 4/5	
Pin #	Definition	Pin #	Definition
1	+5V	1	+5V
2	PO-	2	PO-
3	PO+	3	PO+
4	Ground	4	Ground
5	Key	5	No connection

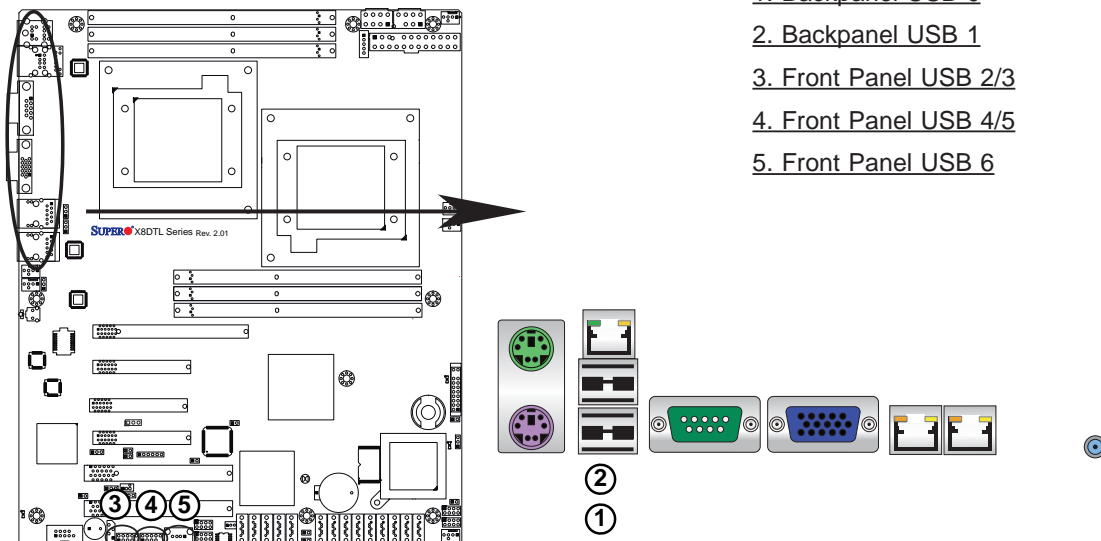

Serial Ports

Two COM connections (COM1 & COM2) are located on the motherboard. COM1 is located on the Backplane IO panel. COM2 is located next to the onboard buzzer to provide additional serial connection support. See the table on the right for pin definitions.

Serial Ports-COM1/COM2 Pin Definitions			
Pin #	Definition	Pin #	Definition
1	DCD	6	DSR
2	RXD	7	RTS
3	TXD	8	CTS
4	DTR	9	RI
5	Ground	10	N/A

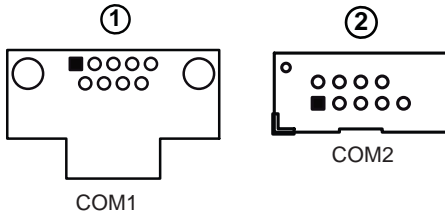

Video Connector

A Video (VGA) connector is located next to COM Port1 on the IO back-plane. This connector is used to provide video display. Refer to the board layout below for the location.

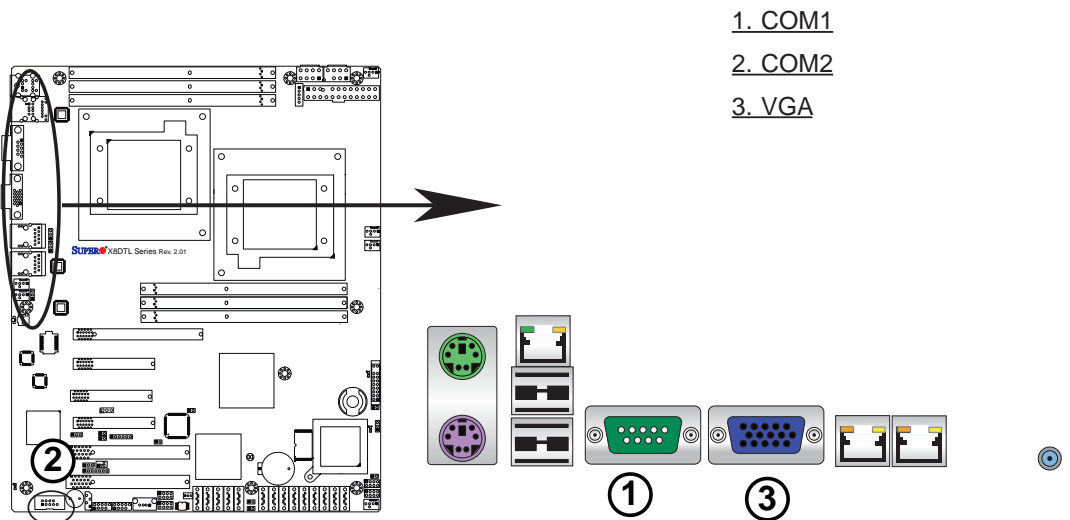
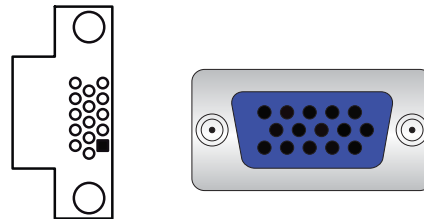

Ethernet Ports

Two Ethernet ports (LAN 1/LAN2) are located at on the IO backplane. In addition, a dedicated LAN is also located on the X8DTL-3F/iF to provide KVM support for IPMI 2.0. All these ports accept RJ45 type cables. (**Note:** Please refer to the LED Indicator Section for LAN LED information.)

LAN Ports Pin Definition			
Pin#	Definition		
1	P2V5SB	10	SGND
2	TD0+	11	Act LED
3	TD0-	12	P3V3SB
4	TD1+	13	Link 100 LED (Yellow, +3V3SB)
5	TD1-	14	Link 1000 LED (Yellow, +3V3SB)
6	TD2+	15	Ground
7	TD2-	16	Ground
8	TD3+	17	Ground
9	TD3-	88	Ground

(NC: No Connection)

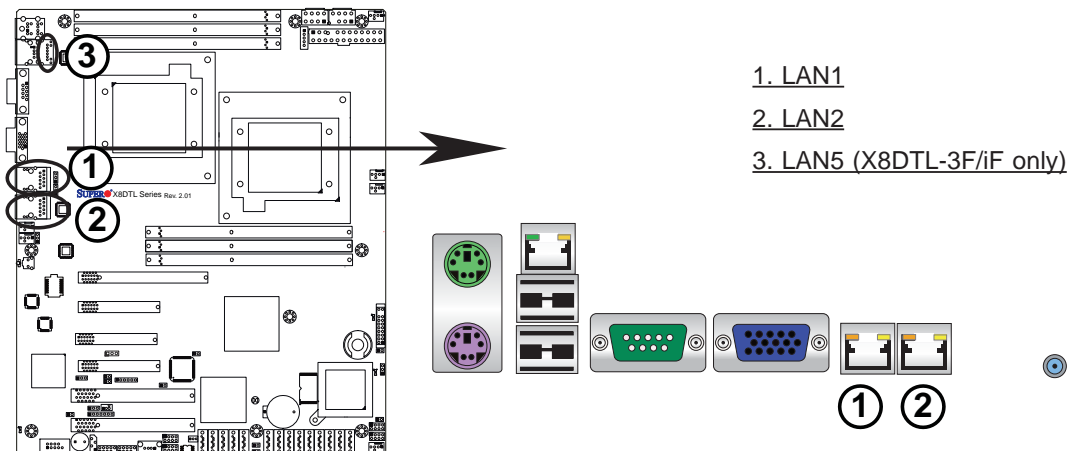

2. Front Control Panel

JF1 contains header pins for various buttons and indicators that are normally located on a control panel at the front of the chassis. These connectors are designed specifically for use with Supermicro server chassis. See the figure below for the descriptions of the various control panel buttons and LED indicators. Refer to the following section for descriptions and pin definitions.

JF1 Header Pins

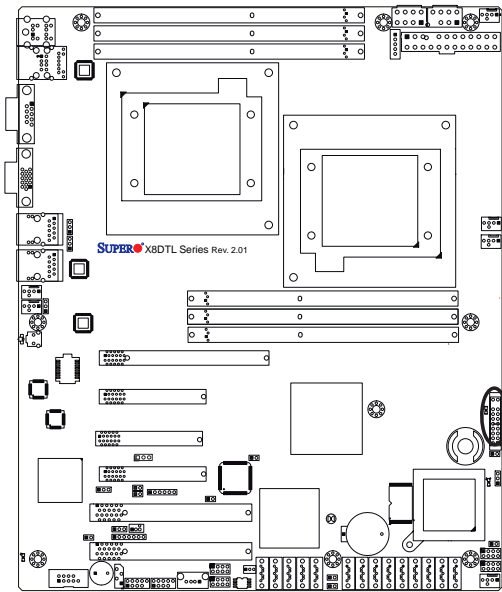

	20	19	
Ground	○	○	NMI
X	○	○	X
Power LED	○	○	Vcc
HDD LED	○	○	Vcc
NIC1 LED	○	○	Vcc
NIC2 LED	○	○	Vcc
OH/Fan Fail LED	○	○	Vcc/Front UID LED
Power Fail LED	○	○	Vcc
Ground	○	○	Reset } Reset Button
Ground	○	○	PWR } Power Button
	2	1	

3. Front Control Panel Pin Definitions

NMI Button

The non-maskable interrupt button header is located on pins 19 and 20 of JF1. Refer to the table on the right for pin definitions.

NMI Button Pin Definitions (JF1)	
Pin#	Definition
19	Control
20	Ground

Power LED

The Power LED connection is located on pins 15 and 16 of JF1. Refer to the table on the right for pin definitions.

Power LED Pin Definitions (JF1)	
Pin#	Definition
15	+5V
16	Ground

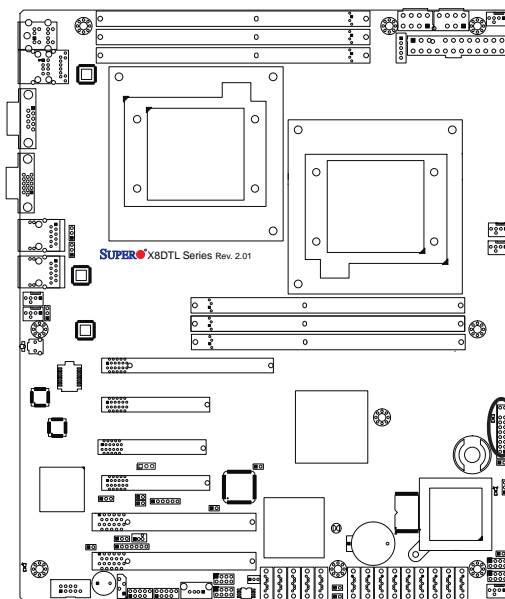

A. NMI

B. PWR LED

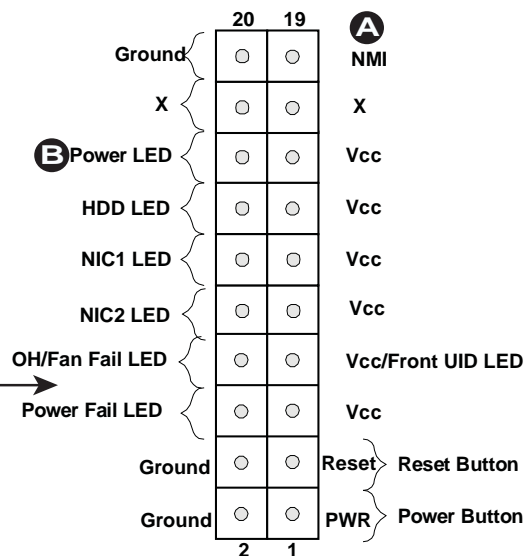

HDD LED

The HDD LED connection is located on pins 13 and 14 of JF1. Attach a cable here to indicate HDD activity. See the table on the right for pin definitions.

HDD LED Pin Definitions (JF1)	
Pin#	Definition
13	+5V
14	HD Active

NIC1/NIC2 LED Indicators

The NIC (Network Interface Controller) LED connection for GLAN port 1 is located on pins 11 and 12 of JF1, and the LED connection for GLAN Port 2 is on Pins 9 and 10. Attach the NIC LED cables to display network activity. Refer to the table on the right for pin definitions.

GLAN1/2 LED Pin Definitions (JF1)	
Pin#	Definition
9/11	Vcc
10/12	Ground

- A. HDD LED
- B. NIC1 LED
- C. NIC2 LED

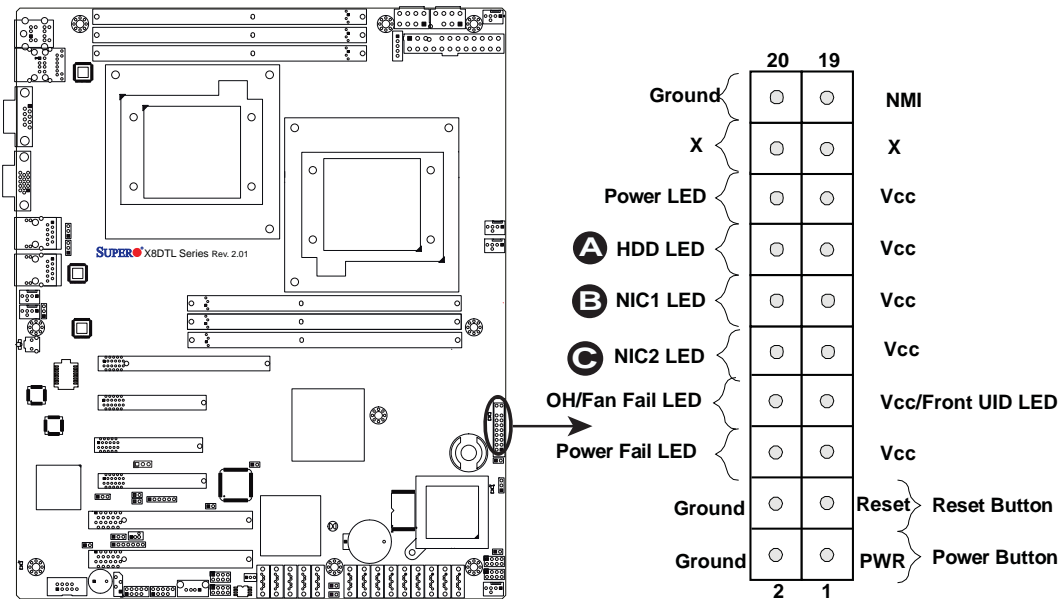

Overheat (OH)/Fan Fail/PWR Fail/UID LED

Connect an LED cable to pins 7 and 8 of JF1 to use the Overheat/Fan Fail/Power Fail and UID LED connections. The Red LED on pin 7 provides warnings of an overheat, fan failure or power failure. The Blue LED on pin 8 works as the front panel UID LED indicator. The Red LED takes precedence over the Blue LED by default. Refer to the table on the right for pin definitions.

OH/Fan Fail LED Pin Definitions (JF1)	
Pin#	Definition
7	Vcc/Front UID LED
8	OH/Fan Fail LED

OH/Fan Fail Indicator Status	
State	Definition
Off	Normal
On	Overheat
Flashing	Fan Fail

Power Fail LED

The Power Fail LED connection is located on pins 5 and 6 of JF1. Refer to the table on the right for pin definitions.

PWR Fail LED Pin Definitions (JF1)	
Pin#	Definition
5	Vcc
6	Ground

- A. OH/Fan Fail & UID LEDs
- B. PWR Supply Fail

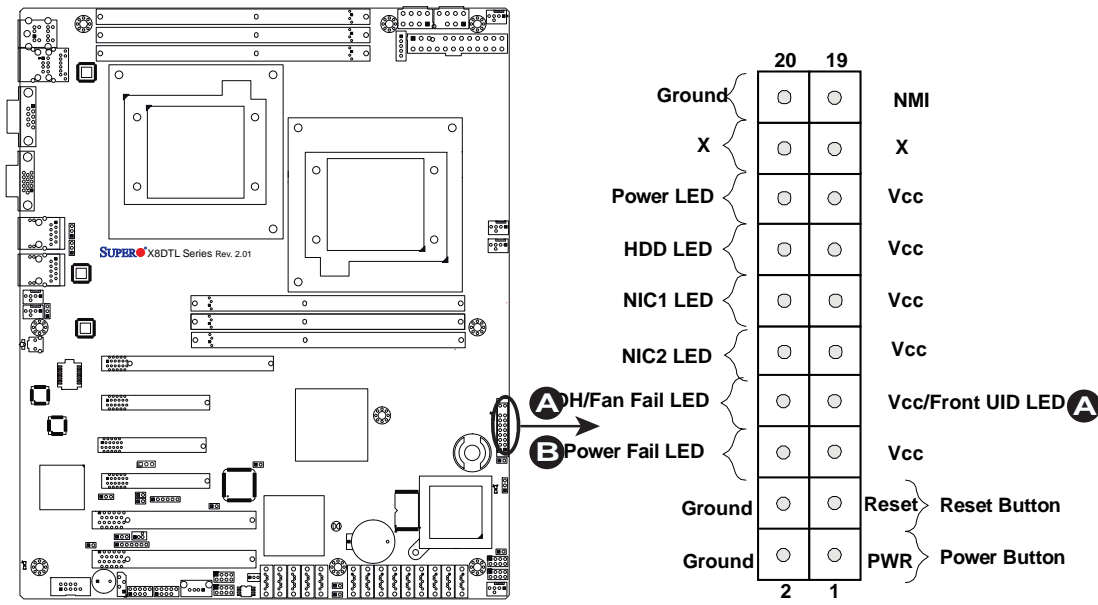

Reset Button

The Reset Button connection is located on pins 3 and 4 of JF1. Attach it to a hardware reset switch on the computer case. Refer to the table on the right for pin definitions.

Reset Button Pin Definitions (JF1)	
Pin#	Definition
3	Reset
4	Ground

Power Button

The Power Button connection is located on pins 1 and 2 of JF1. Momentarily contacting both pins will power on/off the system. This button can also be configured to function as a suspend button (with a setting in the BIOS - see Chapter 4). To turn off the power when set to suspend mode, press the button for at least 4 seconds. Refer to the table on the right for pin definitions.

Power Button Pin Definitions (JF1)	
Pin#	Definition
1	Signal
2	+3V Standby

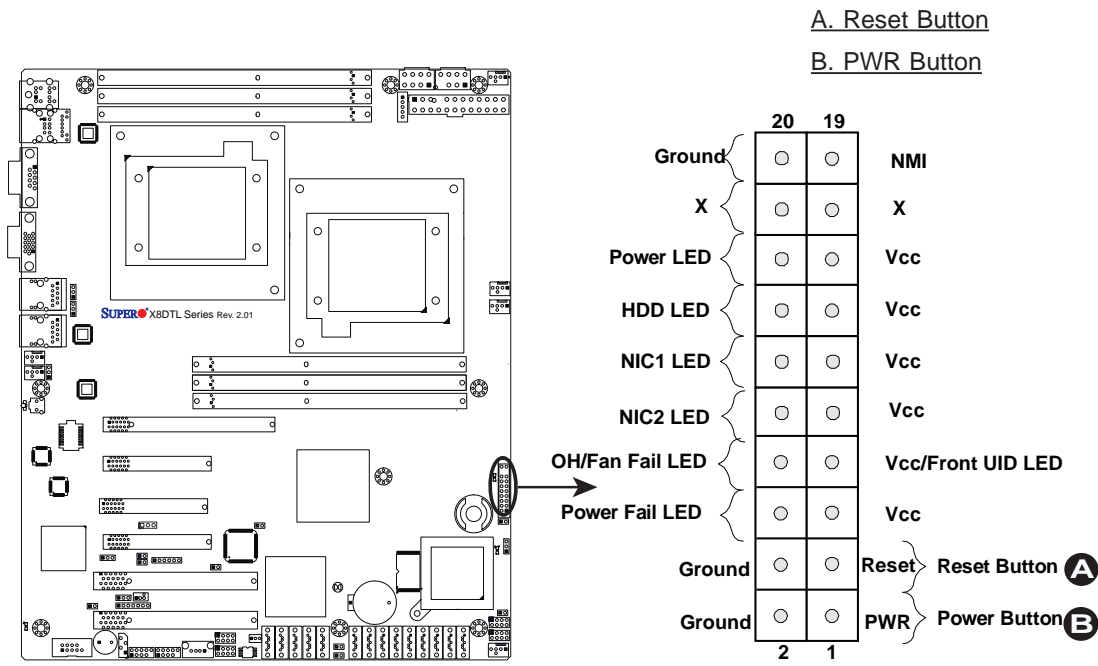

2-6 Connecting Cables

Power Connectors

A 24-pin main power supply connector (JPW1) and two 8-pin CPU PWR connectors (JPW2/JPW3) on the motherboard. These power connectors meet the SSI EPS 12V specification. In addition to the 24-pin ATX power connector, the 12V 8-pin CPU PWR connectors at JPW2/JPW3 must also be connected to your power supply. See the table on the right for pin definitions.



Warning: To prevent damage to the power supply or motherboard, please use a power supply that contains a 24-pin and two 8-pin power connectors. Be sure to connect these connectors to the 24-pin (JPW1) and the two 8-pin (JPW2, JPW3) power connectors on the motherboard. Failure in doing so will void the manufacturer warranty on your power supply and motherboard.

ATX Power 24-pin Connector Pin Definitions			
Pin#	Definition	Pin #	Definition
13	+3.3V	1	+3.3V
14	-12V	2	+3.3V
15	COM	3	COM
16	PS_ON	4	+5V
17	COM	5	COM
18	COM	6	+5V
19	COM	7	COM
20	Res (NC)	8	PWR_OK
21	+5V	9	5VSB
22	+5V	10	+12V
23	+5V	11	+12V
24	COM	12	+3.3V

12V 8-pin PWR Connector Pin Definitions	
Pins	Definition
1 through 4	Ground
5 through 8	+12V

(Required)

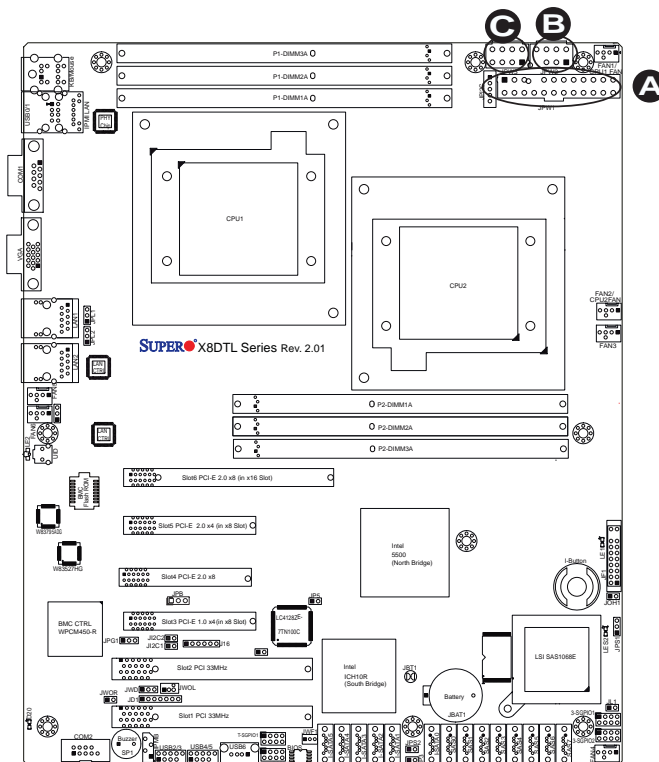

A. 24-pin ATX PWR (Req'd)
 B/C. 8-pin Processor PWR (Req'd)

Fan Headers

This motherboard has four chassis/system fan headers (Fan 3 to Fan 6) and two CPU fans (Fan 1/Fan 2) on the motherboard. All these 4-pin fan headers are backward compatible with the traditional 3-pin fans. However, fan speed control is available for 4-pin fans only. The fan speeds are controlled by Thermal Management via Hardware Monitoring in the Advanced Setting in the BIOS. (The Default setting is Disabled.) See the table on the right for pin definitions.

Fan Header Pin Definitions	
Pin#	Definition
1	Ground
2	+12V
3	Tachometer
4	PWR Modulation

Chassis Intrusion

A Chassis Intrusion header is located at JL1 on the motherboard. Attach an appropriate cable from the chassis to inform you of a chassis intrusion when the chassis is opened.

Chassis Intrusion Pin Definitions (JL1)	
Pin#	Definition
1	Intrusion Input
2	Ground

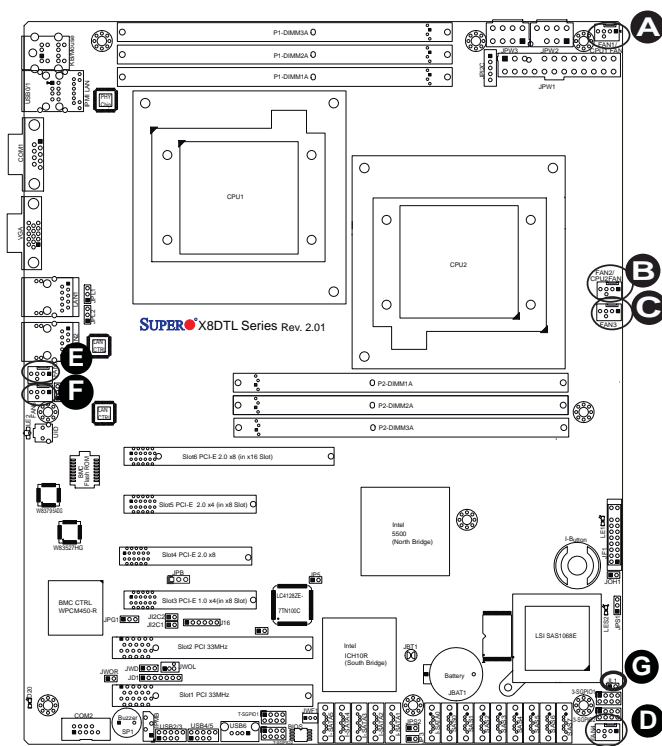

- A. Fan 1 (CPU1 Fan)
- B. Fan 2 (CPU2 Fan)
- C. Fan 3
- D. Fan 4
- E. Fan 5
- F. Fan 6
- G. Chassis Intrusion

Internal Speaker

The Internal Speaker, located at SP1, can be used to provide audible indications for various beep codes. See the table on the right for pin definitions. Refer to the layout below for the locations of the Internal Buzzer (SP1).

Internal Buzzer (SP1) Pin Definition		
Pin#	Definitions	
Pin 1	Pos. (+)	Beep In
Pin 2	Neg. (-)	Alarm Speaker

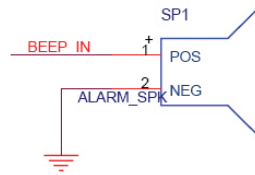

Power LED/Speaker

On the JD1 header, pins 1-3 are used for power LED indication, and pins 4-7 are for the speaker. See the tables on the right for pin definitions. Please note that the speaker connector pins (4-7) are for use with an external speaker. If you wish to use the on-board speaker, you should close pins 6-7 with a jumper.

PWR LED Connector Pin Definitions	
Pin Setting	Definition
Pin 1	Anode (+)
Pin2	Cathode (-)
Pin3	NA

Speaker Connector Pin Definitions	
Pin Setting	Definition
Pins 4-7	External Speaker
Pins 6-7	Internal Speaker

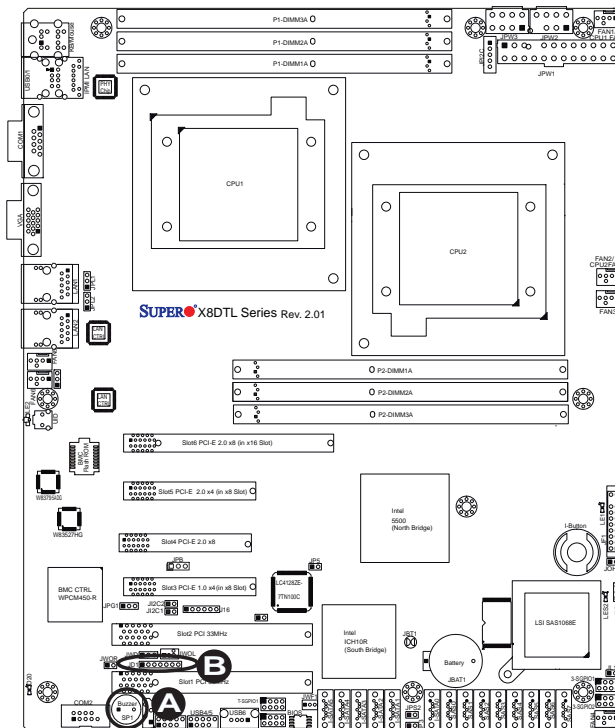

A. Internal Speaker (Buzzer)

B. PWR LED/Speaker

Wake-On-LAN

The Wake-On-LAN header is located at JWOL on the motherboard. You must also have a LAN card with a Wake-On-LAN connector and a cable to use this feature. See the table on the right for pin definitions.

Wake-On-LAN Pin Definitions	
Pin#	Definition
1	+5V Standby
2	Ground
3	Wake-up

Overheat LED/Fan Fail (JOH1)

The JOH1 header is used to connect an LED indicator to provide warnings of chassis overheating or fan failure. This LED will blink when a fan failure occurs. Refer to the table on right for pin definitions.

Overheat LED Pin Definitions	
Pin#	Definition
1	5vDC
2	OH Active

OH/Fan Fail LED Pin Definitions	
State	Message
Solid	Overheat
Blinking	Fan Fail

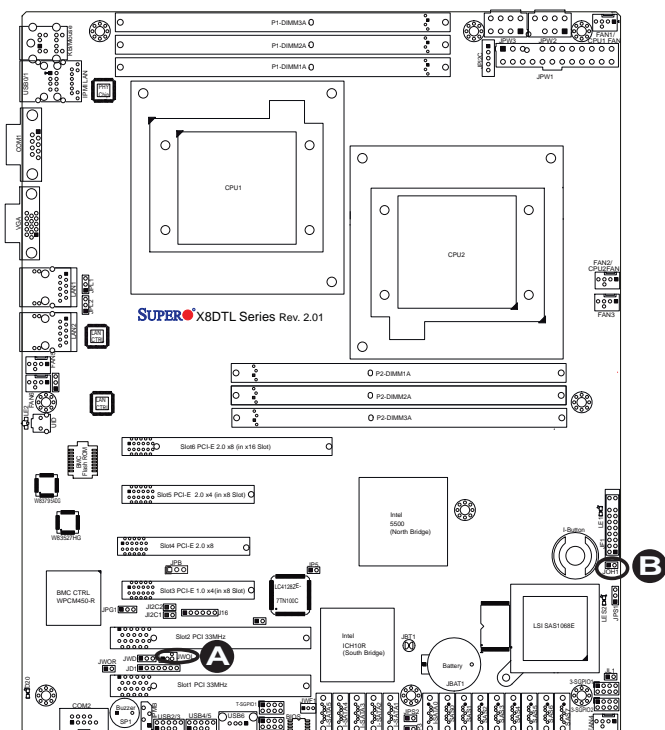

A. Wake-On-LAN

B. Overheat LED

T-SGPIO 1/2 & 3-SGPIO 1/2 Headers

Two SGPIO (Serial-Link General Purpose Input/Output) headers (T-SGPIO-1/T-SGPIO-2) are located on the motherboard. In addition, 3-SGPIO 1/2 located on the X8DTL-3/X8DTL-3F models. These headers support serial link interfaces for the onboard SATA and SAS connectors. See the table on the right for pin definitions. Refer to the board layout below for the location.

T-SGPIO Pin Definitions			
Pin#	Definition	Pin	Definition
1	NC	2	NC
3	Ground	4	Data
5	Load	6	Ground
7	Clock	8	NC

Note: NC= No Connections

I-Button (For X8DTL-3/3F only)

An onboard I-Button, located next to USB Ports 2~3, is a 1-wire computer chip enclosed in a durable stainless steel can. I-Button stores instructions, provides electronic interface and allows HostRAID to operate with Mega-RAID firmware.

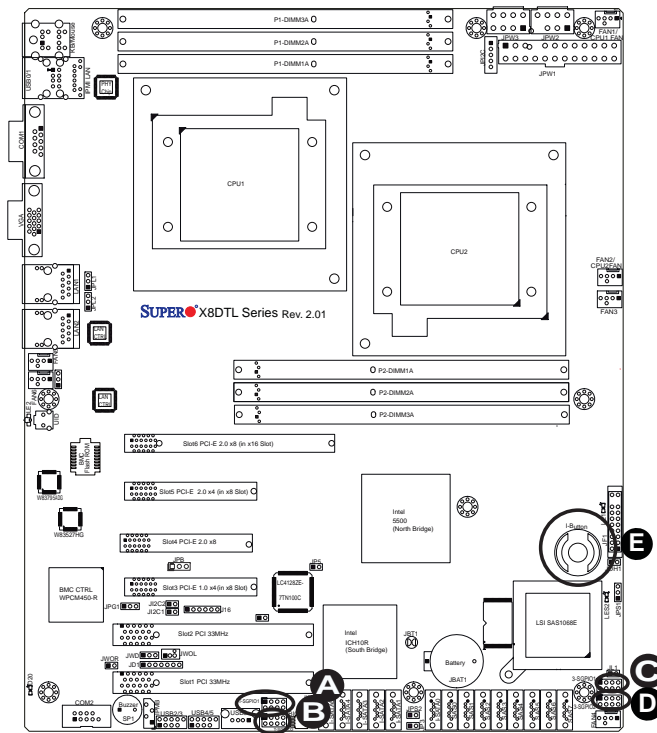

A. T-SGPIO-1

B. T-SGPIO-2

C. 3T-SGPIO-1 (X8DTL-3/3F)

D. 3T-SGPIO-2 (X8DTL-3/3F)

E. I-Button (X8DTL-3/3F)

Power SMB (I²C) Connector

Power System Management Bus (I²C) Connector (JPI²C) monitors power supply, fan and system temperatures. See the table on the right for pin definitions.

PWR SMB Pin Definitions	
Pin#	Definition
1	Clock
2	Data
3	PWR Fail
4	Ground
5	+3.3V

IPMB

An System Management Bus header for IPMI 2.0 is located at IPMB. Connect the appropriate cable here to use the IPMB I²C connection on your system.

SMB Header Pin Definitions	
Pin#	Definition
1	Data
2	Ground
3	Clock
4	No Connection

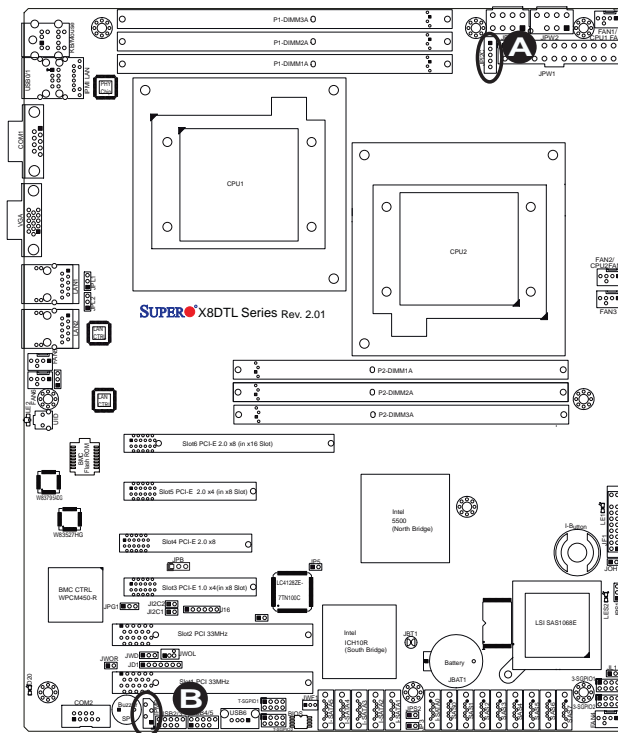

A. PWR SMB

B. IPMB SMB

Unit Identification Switch/LEDs

There are three Unit Identification (UID) devices on the motherboard. A rear UID switch and a rear UID LED indicator are located next to Fan 6 on the back of the chassis. The Front Panel UID LED is connected to a pin in the Front Control Panel (Pin 7 of JF1). When the user pushes the rear UID switch, the Front Panel UID LED and the backplane UID LED (LE2) will be turned on. Push the rear UID switch again to turn off both Indicators. These UID Indicators provide easy identification of a system unit that may be in need of service.

UID Switch	
Pin#	Definition
1	Ground
2	Ground
3	Button In
4	Ground

DOM Power Connector

A power connector for the SATA DOM (Disk_On_Module) devices is located at JWF1. Connect an appropriate cable here to provide power support for your DOM devices. (This connector is available on the PCB R2.01 or a later version board only.)

DOM PWR Pin Definitions	
Pin#	Definition
1	+5V
2	Ground
3	Ground

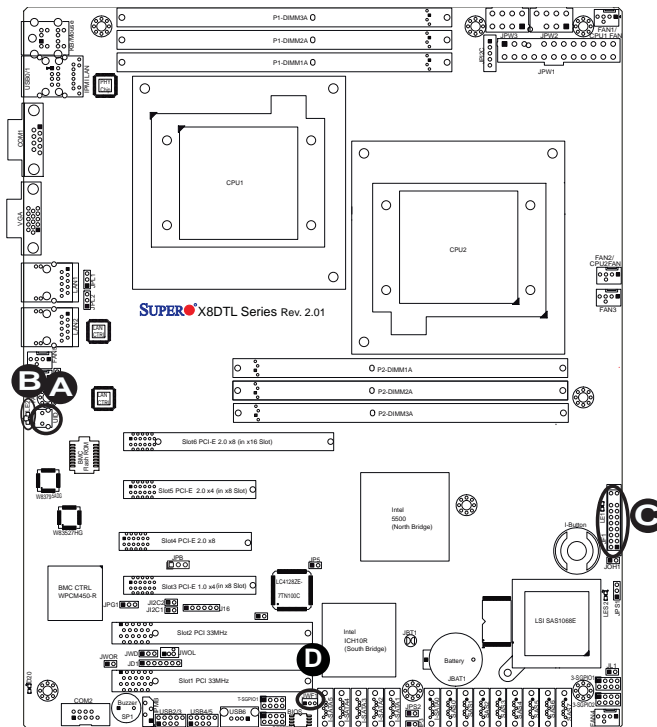

A. Rear UID Switch

B. Rear UID LED (LE2)

C. Front UID LED (Pin 7 of JF1)

D. DOM PWR

Wake-On-Ring

The Wake-On-Ring header is designated JWOR, which will allow your system to wake up when it receives an incoming call to the modem while in the suspend state. See the table on the right for pin definitions. You must have a Wake-On-Ring card and cable to use this feature. (This header is available on the PCB R2.01 or a later version board only.)

Wake-On-Ring Pin Definitions (JWOR)	
Pin#	Definition
1	Ground
2	Wake-up

A. Wake-On-Ring

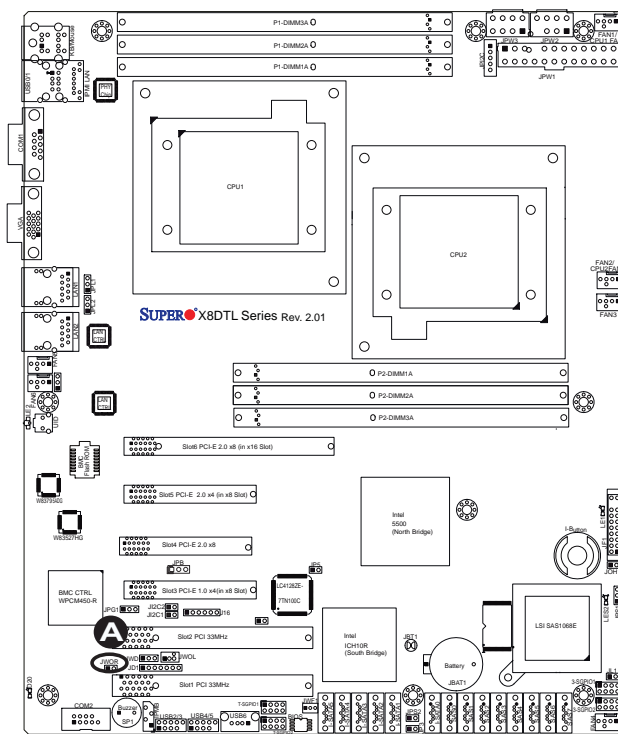

2-7 Jumper Settings

Explanation of Jumpers

To modify the operation of the motherboard, jumpers can be used to choose between optional settings. Jumpers create shorts between two pins to change the function of the connector. Pin 1 is identified with a square solder pad on the printed circuit board. See the motherboard layout pages for jumper locations.

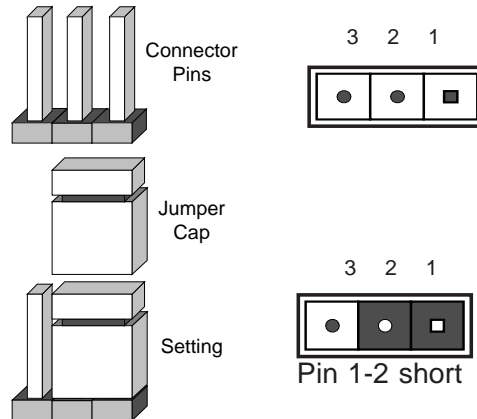

Note: On two pin jumpers, "Closed" means the jumper is on and "Open" means the jumper is off the pins.



GLAN Enable/Disable

JPL1/JPL2 enable or disable the GLAN Port1/GLAN Port2 on the motherboard. See the table on the right for jumper settings. The default setting is **Enabled**.

GLAN Enable Jumper Settings	
Pin#	Definition
1-2	Enabled (default)
2-3	Disabled

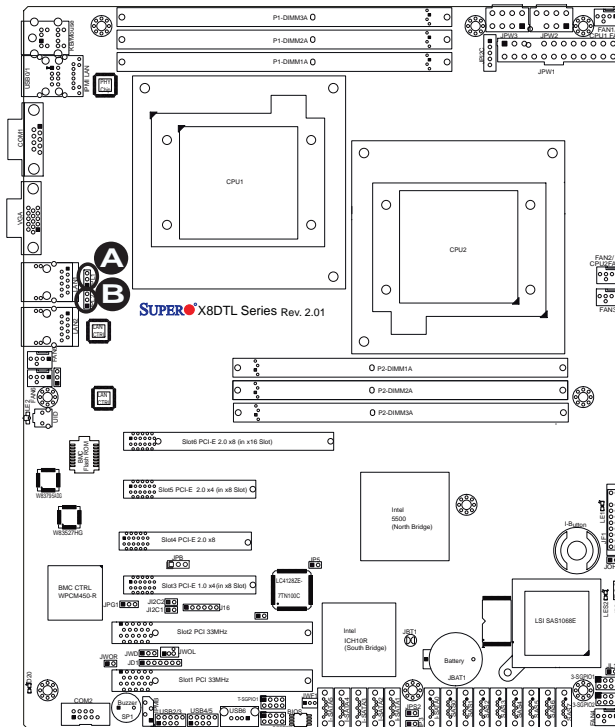

- A. GLAN Port 1 Enable
- B. GLAN Port 2 Enable

CMOS Clear

JBT1 is used to clear CMOS. Instead of pins, this "jumper" consists of contact pads to prevent the accidental clearing of CMOS. To clear CMOS, use a metal object such as a small screwdriver to touch both pads at the same time to short the connection. Always remove the AC power cord from the system before clearing CMOS.



Note 1. For an ATX power supply, you must completely shut down the system, remove the AC power cord and then short JBT1 to clear CMOS.

Note 2. Be sure to remove the onboard CMOS Battery before you short JBT1 to clear CMOS.

Watch Dog Enable/Disable

Watch Dog (JWD) is a system monitor that can reboot the system when a software application hangs. Close Pins 1-2 to reset the system if an application hangs. Close Pins 2-3 to generate a non-maskable interrupt signal for the application that hangs. See the table on the right for jumper settings. Watch Dog must also be enabled in the BIOS.

Watch Dog Jumper Settings (JWD)	
Jumper Setting	Definition
Pins 1-2	Reset (default)
Pins 2-3	NMI
Open	Disabled

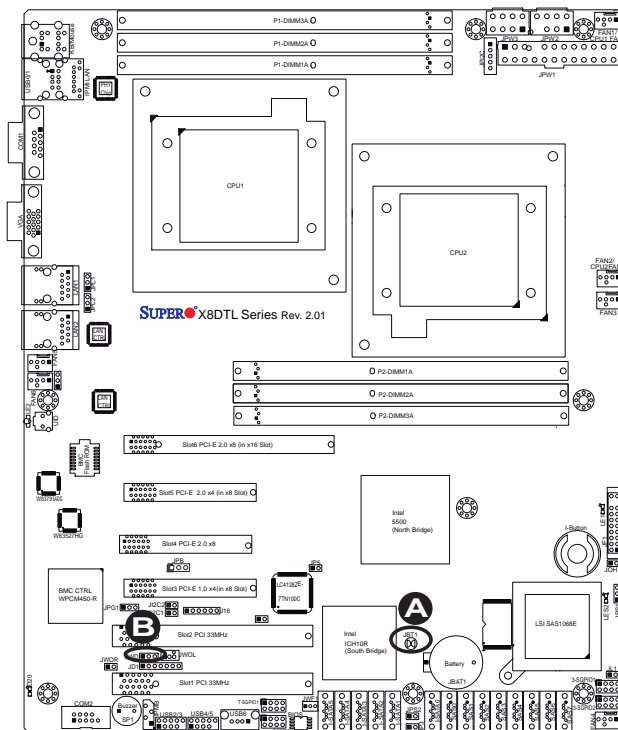

A. Clear CMOS

B. Watch Dog Enable

I²C Bus to PCI-Exp. Slots

Jumpers JI²C1 and JI²C2 allow you to connect the System Management Bus (I²C) to PCI and PCI-Express slots. These two jumpers are to be set at the same time. The default setting is Open to disable the connections. See the table on the right for jumper settings.

I ² C for PCI/PCI-E slots Jumper Settings	
Jumper Setting	Definition
Closed	Enabled
Open	Disabled (Default)

VGA Enable

Jumper JPG1 allows the user to enable the onboard VGA connector. The default setting is 1-2 to enable the connection. See the table on the right for jumper settings.

VGA Enable Jumper Settings	
Jumper Setting	Definition
1-2	Enabled (Default)
2-3	Disabled

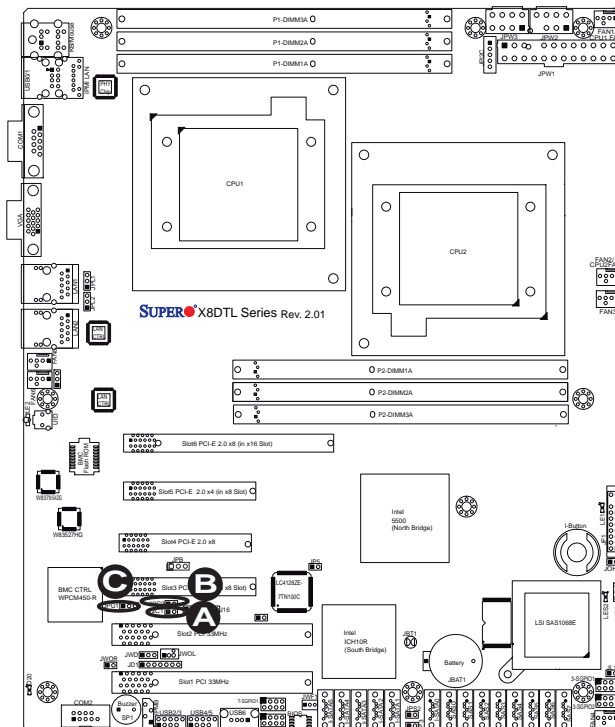

- A. J²C1
- B. J²C2
- C. VGA Enable

**SAS Enable/Disable (X8DTL-3/
X8DTL-3F only)**

Jumper JPS1 allows you to enable or disable the onboard SAS connections. The default setting is Pins 1-2 to enable the connection. See the table on the right for jumper settings.

SAS Enable Jumper Settings	
Jumper Setting	Definition
1-2	SAS Enabled (Default)
2-3	SAS Disabled

**SAS RAID Mode Select (X8DTL-3/
X8DTL-3F only)**

Jumper JPS2 allows you to select RAID Configuration settings for the onboard SAS connections. See the table on the right for jumper settings.

SAS RAID Config. Select Jumper Settings	
Jumper Setting	Definition
Open	Integrated Target Mode (IT)
Closed	Software RAID (SR) (Default)



Note: For more information on LSI SAS RAID configuration, please refer to the LSI MegaRAID User's Guide posted on our website @ <http://www.supermicro.com/support/manuals/>.

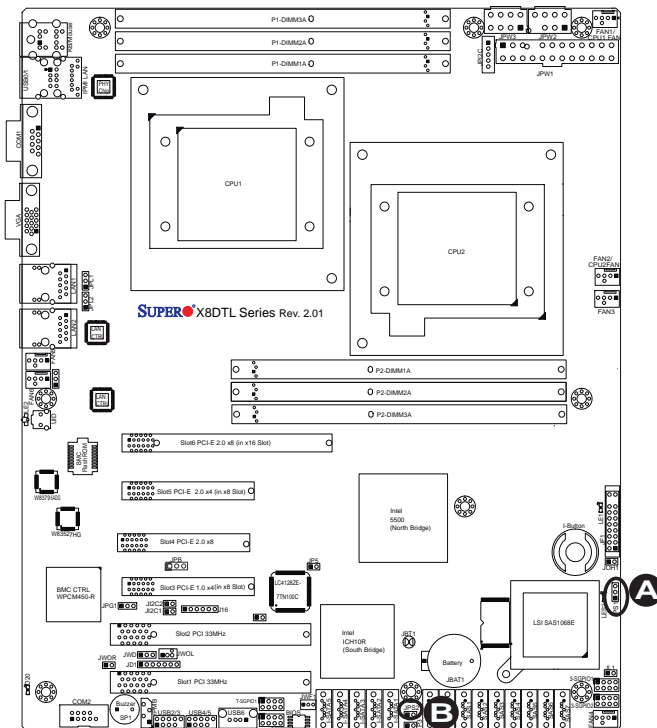

- A. SAS Enable
- B. SAS RAID Config. Select

2-8 Onboard LED Indicators

GLAN LEDs

Two LAN ports (LAN 1/LAN 2) are located on the IO Backplane of the motherboard. In addition, LAN3/LAN4 are located on the X8DTL-3/i-LN4F. Each Ethernet LAN port has two LEDs. The yellow LED indicates activity, while the other Link LED may be green, amber or off to indicate the speed of the connections. See the tables at right for more information.

IPMI Dedicated LAN LEDs (X8DTL-iF/-3F)

In addition to LAN 1/LAN 2, an IPMI Dedicated LAN is also located on the IO Backplane of the X8DTL-iF/3F. The amber LED on the right indicates activity, while the green LED on the left indicates the speed of the connection. See the tables at right for more information.

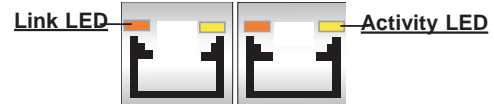

Rear View (when facing the rear side of the chassis)

LAN 1/LAN 2 Activity LED LED State		
Color	Status	Definition
Yellow	Flashing	Active

LAN 1/LAN 2 Link LED LED State	
LED Color	Definition
Off	No Connection or 10 Mbps
Green	100 Mbps
Amber	1 Gbps

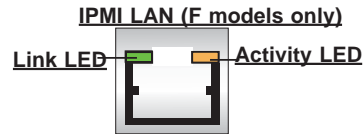

IPMI LAN Link LED & Activity LED		
	Color/State	Definition
Link (Left)	Green: Solid	100 Mbps
Activity (Right)	Amber: Blinking	Active

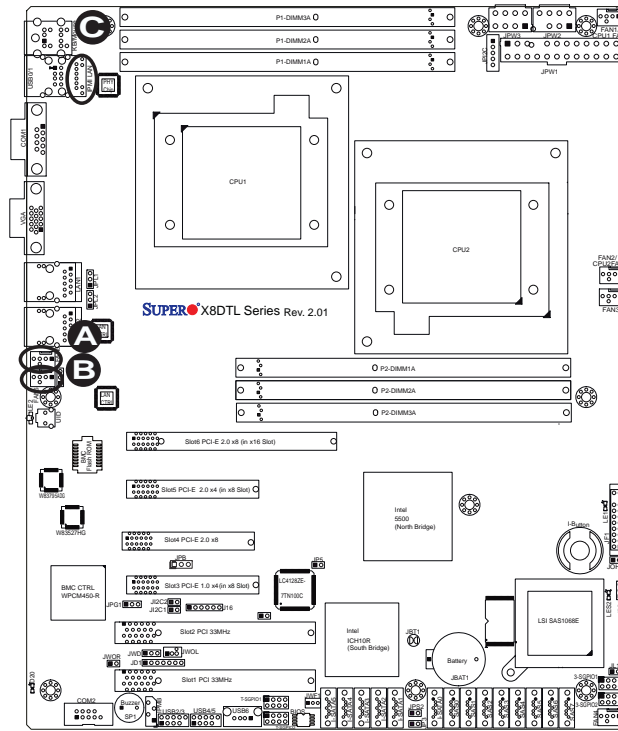

- A. LAN1 LEDs
- B. LAN2 LEDs
- C. Dedicated LAN LEDs (X8DTL-iF/3F)

SAS Heartbeat LED (X8DTL-3/-3F)

An Onboard SAS Heartbeat LED is located on the motherboard. When LES2 is blinking, SAS functions normally. See the table at right for more information.

SAS Heartbeat LED (LES2) State	
State	Definition
Blinking	SAS: Normal

BMC Heartbeat LED (X8DTL-iF/3F)

A BMC Heartbeat LED is located at D20 on the motherboard. When D20 is blinking, BMC functions normally. See the tables at right for more information.

BMC Heartbeat LED (D20) State	
State	Definition
Blinking	BMC: Normal

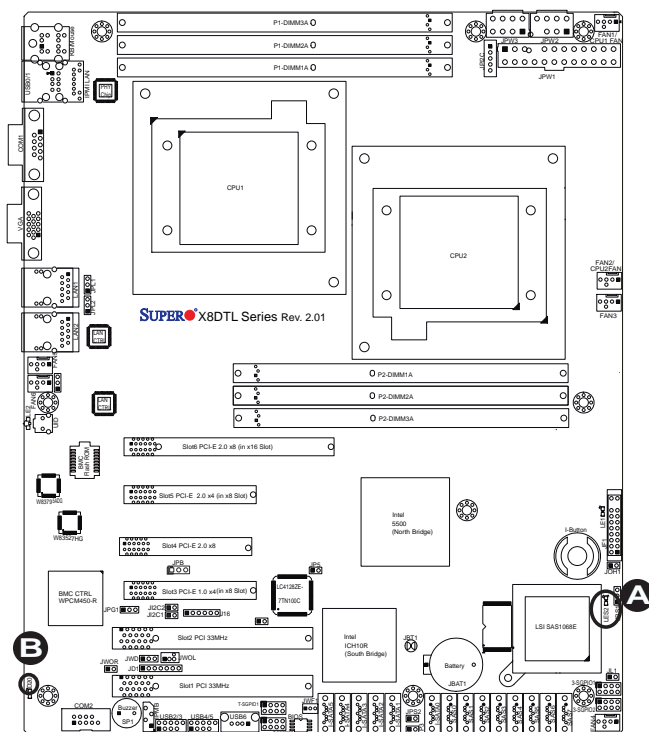

A. SAS Heartbeat LED

B. BMC LED

Onboard Power LED

An Onboard Power LED is located at LE1 on the motherboard. When this LED is lit, the system is on. Be sure to turn off the system and unplug the power cord before removing or installing components. See the tables at right for more information.

Onboard PWR LED (LE1) State	
State/Color	Definition
Off	System Off (PWR cable not connected)
Green	System Power On

Rear UID LED

The rear UID LED is located at LE2 on the backplane. This LED is used in conjunction with the front UID LED on the Front Control Panel and the rear UID switch to provide easy identification of a system that might be in need of service. Refer to UID Switch/LEDs on Page 2-26 for more information. See the tables at right for more information.

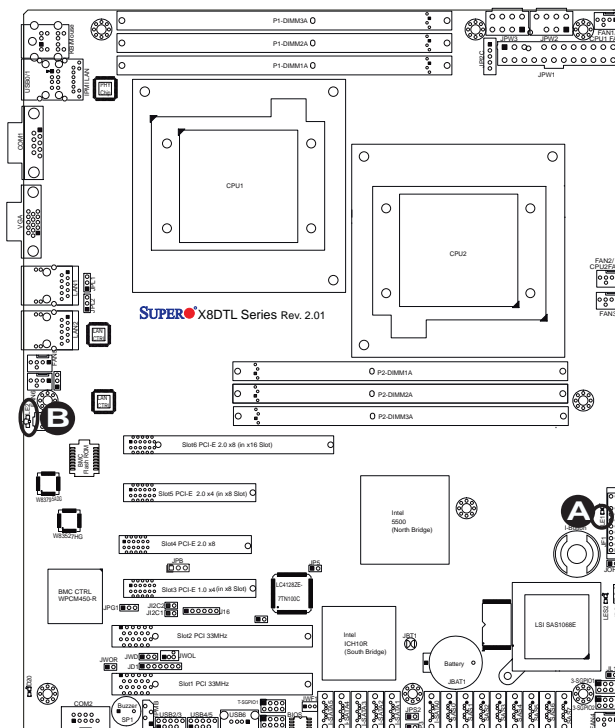

A. Onboard PWR LED

B. UID Rear LED

2-9 Serial ATA and SAS Connections

Serial ATA Ports

There are Six Serial ATA Ports (I-SATA0~I-SATA 5) located on the motherboard. These ports provide serial-link signal connections, which are faster than the connections of Parallel ATA. See the table on the right for pin definitions.

Serial ATA Pin Definitions	
Pin#	Definition
1	Ground
2	TX_P
3	TX_N
4	Ground
5	RX_N
6	RX_P
7	Ground

SAS Ports (X8DTL-3/X8DTL-3F only)

SAS Ports 0~7 provide SAS (Serial-Attached SCSI) connections on the X8DTL-3/X8DTL-3F. See the layout below for SAS port locations.



Note 1: For more information on SATA HostRAID configuration, please refer to the Intel SATA HostRAID User's Guide posted on our website @ <http://www.supermicro.com/support/manuals/>.

Note 2: For more information on LSI SAS RAID configuration, please refer to the LSI MegaRAID User's Guide posted on our website @ <http://www.supermicro.com/support/manuals/>.

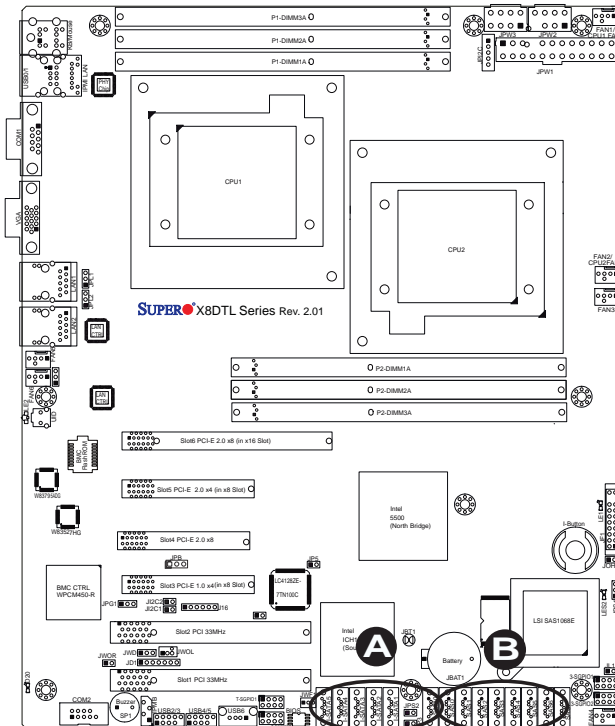

A. I-SATA0~5

B.SAS 0~7 (X8DTL-3/-3F)

Chapter 3

Troubleshooting

3-1 Troubleshooting Procedures

Use the following procedures to troubleshoot your system. If you have followed all of the procedures below and still need assistance, refer to the 'Technical Support Procedures' and/or 'Returning Merchandise for Service' section(s) in this chapter. Note: Always disconnect the power cord before adding, changing or installing any hardware components.

Before Power On

1. Make sure that there are no short circuits between the MB and the chassis.
2. Disconnect all ribbon/wire cables from the motherboard, including those for the keyboard and mouse. Also, Remove all add-on cards.
3. Install CPU 1 first (making sure it is fully seated), and connect the chassis speaker and the power LED to the motherboard. Check all jumper settings as well.

No Power

1. Make sure that there are no short circuits between the motherboard and the chassis.
2. Make sure that all jumpers are set to their default positions.
3. Check that the 115V/230V switch on the power supply is properly set.
4. Turn the power switch on and off to test the system.
5. The battery on your motherboard may be old. Check to verify that it still supplies ~3VDC. If it does not, replace it with a new one.

No Video

1. If the power is on, but you have no video - Remove all the add-on cards and cables.

2. Use the speaker to determine if any beep codes exist. Refer to the Appendix for details on beep codes.

Losing the System's Setup Configuration

1. Make sure that you are using a high quality power supply. A poor quality power supply may cause the system to lose the CMOS setup information. Refer to Section 1-6 for details on recommended power supplies.
2. The battery on your motherboard may be old. Check to verify that it still supplies ~3VDC. If it does not, replace it with a new one.
3. If the above steps do not fix the Setup Configuration problem, contact your vendor for repairs.

Memory Errors

When a No_Memory_Beep_Code is issued by the system, check the following:

1. Make sure that the DIMM modules are properly and fully installed.
2. Check if different speeds of DIMMs have been installed. It is strongly recommended to use the same RAM speed for all DIMMs in the system.
3. Make sure you are using the correct type of Registered ECC or Unbuffered ECC/Non-ECC DDR3 1333/1066/800 MHz SDRAM as recommended.
4. Check for bad DIMM modules or slots by swapping a single module between all memory slots and check the results.
5. Make sure that all memory modules are fully seated in their slots. Make sure to follow the instructions given on DIMM population in Section 2-4 in Chapter 2.
6. Check the position of the 115V/230V switch on the power supply.
7. Please follow the instructions given in the DIMM Population Tables listed on Page 2-8 to install your memory modules.

3-2 Technical Support Procedures

Before contacting Technical Support, please take the following steps. Also, please note that as a motherboard manufacturer, Supermicro does not sell directly to end-

users, so it is best to first check with your distributor or reseller for troubleshooting services. They should know of any possible problem(s) with the specific system configuration that was sold to you.

1. Please go through the 'Troubleshooting Procedures' and 'Frequently Asked Question' (FAQ) sections in this chapter or see the FAQs on our web site (<http://www.supermicro.com/support/faqs/>) before contacting Technical Support.
2. BIOS upgrades can be downloaded from our web site at (<http://www.supermicro.com/support/bios/>).
3. If you still cannot resolve the problem, include the following information when contacting Supermicro for technical support:
 - Motherboard model and PCB revision number
 - BIOS release date/version (this can be seen on the initial display when your system first boots up)
 - System configuration
 - An example of a Technical Support form is on our web site at (<http://www.supermicro.com/support/contact.cfm>).
 - Distributors: For immediate assistance, please have your account number ready when placing a call to our technical support department. We can be reached by e-mail at support@supermicro.com or by fax at: (408) 503-8000, option 2.

3-3 Frequently Asked Questions

Question: What are the various types of memory that my motherboard can support?

Answer: The X8DTL-3/X8DTL-i/X8DTL-3F/X8DTL-iF has six 240-pin DIMM slots that support 96 GB Registered ECC or 24 GB Unbuffered ECC/Non-ECC DDR3 1333/1066/800 MHz SDRAM modules. It is strongly recommended that you do not mix memory modules of different speeds and sizes. Please follow all memory installation instructions given on Section 2-4 in Chapter 2.

Question: How do I update my BIOS?

Answer: It is recommended that you **do not** upgrade your BIOS if you are not experiencing any problems with your system. Updated BIOS files are located on our web site at <http://www.supermicro.com/support/bios/>. Please check our BIOS

warning message and the information on how to update your BIOS on our web site. Select your motherboard model and download the BIOS file to your computer. Also, check the current BIOS revision and make sure that it is newer than your BIOS before downloading. You can choose from the zip file and the .exe file. If you choose the zip BIOS file, please unzip the BIOS file onto a bootable USB device. Run the batch file using the format flash.bat filename.rom from your bootable USB device to flash the BIOS. Then, your system will automatically reboot. Please note that this process may take a few minutes to complete. Do not be concerned if the screen is paused for a few minutes.



Warning: Do not shut down or reset the system while updating the BIOS to prevent possible system boot failure!



Note 1. After flashing the BIOS, make sure to clear the CMOS (as indicated on Page 2-28.)

Note 2. The SPI BIOS chip used on this motherboard cannot be removed. Send your motherboard back to our RMA Department for repair.

Note 3. Please handle used batteries carefully. Do not damage the battery in any way; a damaged battery may release hazardous materials into the environment. Do not discard a used battery in the garbage or a public landfill. Please comply with the regulations set up by your local hazardous waste management agency to dispose of your used battery properly.

Question: What's on the CD that came with my motherboard?

Answer: The supplied CD has drivers and programs that are needed for your system. Please review the CD and install the applications you need. Applications on the CD include chipset drivers for the Windows OS, security and audio drivers.

3-4 Returning Merchandise for Service

A receipt or copy of your invoice marked with the date of purchase is required before any warranty service will be rendered. You can obtain service by calling your vendor for a Returned Merchandise Authorization (RMA) number. When returning to the manufacturer, the RMA number should be prominently displayed on the outside of the shipping carton, and mailed prepaid or hand-carried. Shipping and handling charges will be applied for all orders that must be mailed when service is complete. For faster service, You can also request a RMA authorization online (<http://www.supermicro.com/support/rma/>).

This warranty only covers normal consumer use and does not cover damages incurred in shipping or from failure due to the alternation, misuse, abuse or improper maintenance of products.

During the warranty period, contact your distributor first for any product problems.

Chapter 4

BIOS

4-1 Introduction

This chapter describes the AMI BIOS Setup utility for the X8DTL-3/-i/-3F/-iF motherboard. The AMI ROM BIOS is stored in a Flash EEPROM and can be easily updated. This chapter describes the basic navigation of the AMI BIOS Setup utility setup screens.

Starting BIOS Setup Utility

To enter the AMI BIOS Setup utility screens, press the <Delete> key while the system is booting up.

 **Note:** In most cases, the <Delete> key is used to invoke the AMI BIOS setup screen. There are a few cases when other keys are used, such as <F1>, <F2>, etc.

Each main BIOS menu option is described in this manual. The Main BIOS setup menu screen has two main frames. The left frame displays all the options that can be configured. Grayed-out options cannot be configured. Options in blue can be configured by the user. The right frame displays the key legend. Above the key legend is an area reserved for a text message. When an option is selected in the left frame, it is highlighted in white, often with a text message attached. (**Note:** the AMI BIOS has default text messages built in. Supermicro retains the option to include, omit, or change any of these text messages.)

The AMI BIOS Setup utility uses a key-based navigation system called "hot keys". Most of the AMI BIOS setup utility "hot keys" can be used at any time during the setup navigation process. These keys include <F1>, <F10>, <Enter>, <ESC>, arrow keys, etc.

 **Note:** Options printed in **Bold** are default settings.

How To Change the Configuration Data

The configuration data that determines the system parameters may be changed by entering the AMI BIOS Setup utility. This Setup utility can be accessed by pressing at the appropriate time during system boot.

 **Note:** For AMI BIOS Recovery, please refer to the AMI BIOS Recovery Instructions posted on our website at <http://www.supermicro.com/support/manuals/>.

Starting the Setup Utility

Normally, the only visible Power-On Self-Test (POST) routine is the memory test. As the memory is being tested, press the <Delete> key to enter the main menu of the AMI BIOS Setup utility. From the main menu, you can access the other setup screens. An AMI BIOS identification string is displayed at the left bottom corner of the screen below the copyright message.

 **Warning!** Do not upgrade the BIOS unless your system has a BIOS-related issue. Flashing the wrong BIOS can cause irreparable damage to the system. In no event shall Supermicro be liable for direct, indirect, special, incidental, or consequential damages arising from a BIOS update. If you have to update the BIOS, do not shut down or reset the system while the BIOS is updating. This is to avoid possible boot failure.

4-2 Main Setup

When you first enter the AMI BIOS Setup utility, you will enter the Main setup screen. You can always return to the Main setup screen by selecting the Main tab on the top of the screen. The Main BIOS Setup screen is shown below.

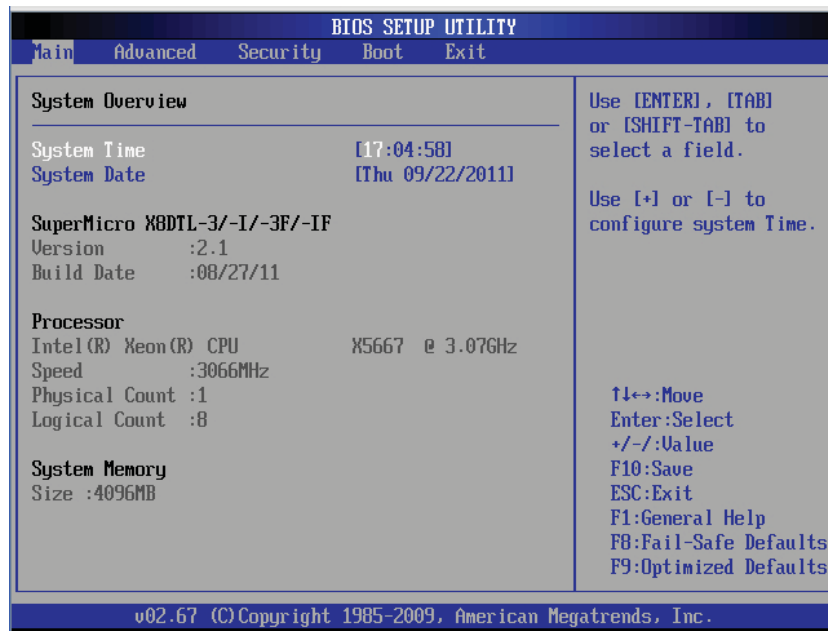

System Overview: The following BIOS information will be displayed:

System Time/System Date

Use this option to change the system time and date. Highlight *System Time* or *System Date* using the arrow keys. Key in new values through the keyboard and press <Enter>. Press the <Tab> key to move between fields. The date must be entered in MM/DD/YY format. The time is entered in HH:MM:SS format. (**Note:** The time is in the 24-hour format. For example, 5:30 P.M. appears as 17:30:00.)

Supermicro X8DTL-3/i/3F/iF

- **Version:** This item displays the BIOS version used in your system.
- **Build Date:** This item displays the date when this BIOS was completed.

Processor

The AMI BIOS will automatically display the status of the processor used in your system:

- **CPU Type:** This item displays the type of CPU used in the motherboard.
- **Speed:** This item displays the speed of the CPU detected by the BIOS.
- **Physical Count:** This item displays the number of processors installed in your system as detected by the BIOS.
- **Logical Count:** This item displays the number of CPU Cores installed in your system as detected by the BIOS.

System Memory

This displays the size of memory available in the system.

4-3 Advanced Setup Configurations

Use the arrow keys to select Boot Setup and press <Enter> to access the submenu items.

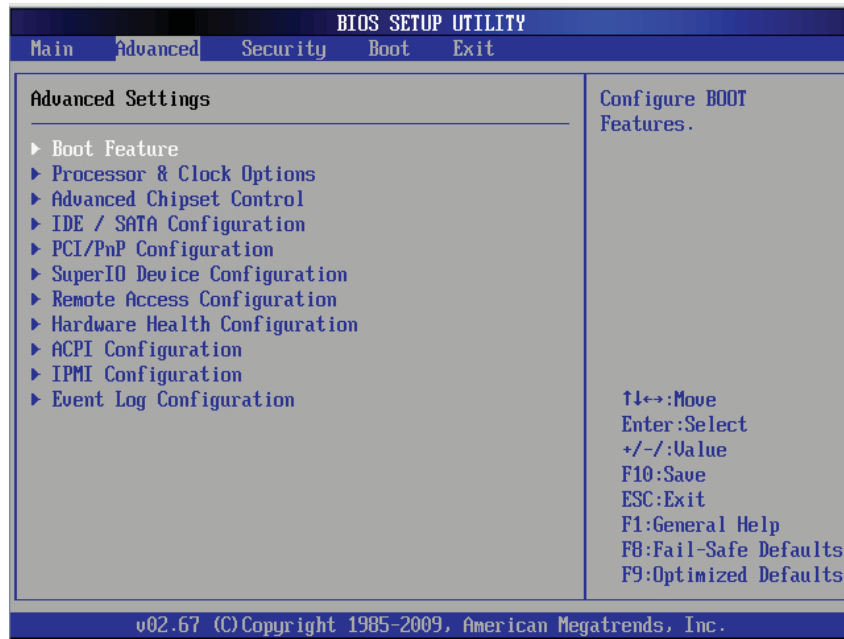

► Boot Features

Quick Boot

Select Enabled to skip certain tests during POST to reduce the time needed for system boot. The options are **Enabled** and Disabled.

Quiet Boot

This feature allows the user to select the bootup screen display between the POST messages or the OEM logo. Select Disabled to display the POST messages. Select Enabled to display the OEM logo instead of the normal POST messages. The options are **Enabled** and Disabled.

AddOn ROM Display Mode

Use this feature to configure Option ROM mode settings. The options are **Force BIOS** and Keep Current.

Bootup Num-Lock

Select On to turn on the Numlock key at bootup. The options are Off and **On**.

Wait For 'F1' If Error

Select Enabled to force the system to wait until the user presses the <F1> key when an error occurs. The options are Disabled and **Enabled**.

Hit 'Del' Message Display

If this feature is set to Enabled, the message: "Press DEL to run Setup" will be displayed during POST. The options are **Enabled** and Disabled.

Interrupt 19 Capture

Interrupt 19 is the software interrupt that handles the boot disk function. When this item is set to Enabled, the ROM BIOS of the host adaptors will "capture" Interrupt 19 at bootup and allow the drives that are attached to these host adaptors to function as bootable disks. If this item is set to Disabled, the ROM BIOS of the host adaptors will not capture Interrupt 19, and the drives attached to these adaptors will not function as bootable devices. The options are **Enabled** and Disabled.

Power Configuration

Watch Dog Function

If enabled, the Watch Dog Timer will cause the system to reboot when it is inactive for more than 5 minutes. The options are Enabled and **Disabled**.

Power Button Function

If this item is set to Instant_Off, the system will power off immediately as soon as the user hits the power button. If set to 4_Second_Override, the system will power off when the user presses the power button for 4 seconds or longer. The options are **Instant_Off** and 4_Second_Override.

Restore on AC Power Loss

Use this feature to set the power state after a power outage. Select Power-Off for the system power to remain off after a power loss. Select Power-On for the system power to be turned on after a power loss. Select Last State to allow the system to resume its last state before a power loss. The options are Power-On, Power-Off and **Last State**.

Resume On RTC Alarm

Use this feature to set an event alarm using the Real Time Clock (RTC) to "wake up" the system at specified times. The options are Enabled and **Disabled**. If this feature is enabled, the following items will display.

RTC Alarm Date (Days) (Available if Resume on RTC Alarm is Enabled)

This option appears if Resume On RTC Alarm is Enabled. The options are **Every Day** and 1 ~ 31 (corresponding to the days of the month.)

RTC Alarm Time (Available if Resume on RTC Alarm is Enabled)

Set the time when the system wakes up during the day specified under the RTC Alarm Date above.

► Processor and Clock Options

This submenu displays the status of the processor used in the motherboard and allows the user to configure the Processor and Clock settings.

- **Type of the CPU:** This item displays the CPU type for the motherboard.
- **Frequency:** This item displays the CPU frequency for the motherboard.
- **CPUID:** This item displays the CPUID for the motherboard.
- **Microcode Revision:** This item displays the CPUID for the motherboard.
- **Cache L1:** This item displays the size of Cache L1 of the CPU for the motherboard.
- **Cache L2:** This item displays the size of Cache L2 of the CPU for the motherboard.
- **Cache L3:** This item displays the size of Cache L3 of the CPU for the motherboard.
- **Ratio Status:** This item displays the status of the CPU ratio.
- **Ratio Actual Value:** This item displays the actual value of the CPU ratio.

CPU Ratio

If set to Manual, this option allows the user to manually set the ratio between the CPU Core Clock and the FSB Frequency. (**Note:** if an invalid ratio is entered, the AMI BIOS will restore the setting to the previous state.) The options are **Auto** and **Manual**.

Clock Spread Spectrum

Select Enable to enable Clock Spectrum support, which will allow the BIOS to monitor and attempt to reduce the level of Electromagnetic Interference caused by the components whenever needed. The options are **Disabled** and **Enabled**.

Hardware Prefetcher (Available when supported by the CPU)

If enabled, the hardware prefetcher will prefetch streams of data and instructions from the main memory to the L2 cache in the forward or backward manner to improve CPU performance. The options are Disabled and **Enabled**.

Adjacent Cache Line Prefetch (Available when supported by the CPU)

The CPU prefetches the cache line for 64 bytes if this option is set to Disabled. The CPU prefetches both cache lines for 128 bytes as comprised if this item is set to **Enabled**. The options are Disabled and **Enabled**.

DCU Prefetcher (Available when supported by the CPU)

Select Enabled to activate Level 1 Data Prefetcher to enhance system performance. For DP servers, enable or disable this feature based on application specifications. The options are **Enabled** and Disabled.

Data Reuse Optimization (Available when supported by the CPU)

Select Enabled to maximize Data Reuse support to enhance system performance for DP platforms. For DP servers, enable or disable this feature based on application specifications. The options are **Enabled** and Disabled.

MPS and ACPI MADT Ordering

This feature allows the user to configure the MPS (Multi-Processor Specification) and ACPI settings for your motherboard. Select **Modern Ordering** if the XP or a newer version of Windows OS is used in the motherboard. Select Legacy Ordering if the 2000 or an earlier version of Windows OS is used. The options are **Modern Ordering** and Legacy Ordering.

Intel® Virtualization Technology (Available when supported by the CPU)

Select Enabled to enable Virtualization Technology support and allows one platform to run multiple operating systems and applications in independent partitions, creating multiple "virtual" systems in one physical computer. The options are **Enabled** and Disabled. **Note:** If there is any change to this setting, you will need to power off and restart the system for the change to take effect. Please refer to Intel's web site for detailed information.

Execute-Disable Bit Capability (Available if supported by the OS and the CPU)

Select Enabled to enable Execute_Disable_Bit support which will allow the processor to designate areas in the system memory where an application code can execute and where it cannot, thus preventing a worm or a virus from flooding illegal codes to overwhelm the processor or damage the system during an attack. The default is **Enabled**. (Refer to Intel and Microsoft Web Sites for more information.)

Intel AES-NI

Select Enable to use the Intel Advanced Encryption Standard (AES) New Instructions (NI) to ensure data security. The options are **Disabled** and **Enabled**.

Simultaneous Multi-Threading (Available when supported by the CPU)

Set to Enabled to use the Simultaneous Multi-Threading Technology to enhance CPU performance. The options are **Disabled** and **Enabled**.

Active Processor Cores

Set to Enabled to use a processor's Second Core and beyond. (Please refer to Intel's web site for more information.) The options are **All**, **1**, and **2**.

Intel® EIST Technology

EIST (Enhanced Intel SpeedStep Technology) allows the system to automatically adjust processor voltage and core frequency in an effort to reduce power consumption and heat dissipation. **Please refer to Intel's web site for detailed information.** The options are **Disabled** and **Enabled**.

Intel® Turbo Boost (Available when EIST Tech. is enabled)

Select Enabled to enable Turbo Mode support to boost system performance. The options are **Enabled**, and **Disabled**.

C1E Support

Select Enabled to enable Enhanced Halt State support. C1E significantly reduces the CPU's power consumption by reducing the CPU's clock cycle and voltage during a "Halt State". The options are **Disabled** and **Enabled**.

Intel® C-STATE Tech

If enabled, C-State is set by the system automatically to C2, C3, or C4 state. The options are **Disabled** and **Enabled**.

C-State Package Limit Setting (Available when the C-State Tech is enabled)

If this package is set to Auto, the AMI BIOS will automatically set a limit on the C-State package register. The options are **Auto**, **C1**, **C3**, **C6**, and **C7**.

C1 Auto Demotion

When this feature is enabled, the CPU will conditionally demote C3, C6 or C7 requests to C1 based on un-core auto-demote information. The options are **Enabled** and **Disabled**.

C3 Auto Demotion

When this feature is enabled, the CPU will conditionally demote C6 or C7 requests to C3 based on un-core auto-demote information. The options are Enabled and **Disabled**.

ACPI T State

Select Enabled to report CPU throttling state in ACPI. The options are Enabled and **Disabled**.

► Advanced Chipset Control

► CPU Bridge Configuration

This feature allows the user to configure CPU Bridge settings.

- **CPU Revision:** This item displays the CPU revision number.
- **Current QPI Frequency:** This item displays current QPI frequency.
- **Current CPU1/CPU2 Memory Frequency:** This item displays current CPU memory frequency.
- **Memory Reference Code:** This item displays the memory reference code.
- **QPI Reference Code:** This item displays the QPI reference code for the motherboard.

Request Transaction ID (Available for the Intel Xeon 5600 platform only)

QuickPath Interconnect (QPI) is the connection between the CPUs and the I/O hub (IOH). For a transaction to be processed in the QPI, a "Transaction ID" is required, and it is assigned by an agent (CPU1, CPU2 or the IOH). Each agent is allocated a number of Transaction IDs based on the QPI IO Bandwidth and the Request Transaction ID (RTID) setting (32-24-32 or 32-16-40). Once Transaction IDs are allocated to an agent, it will assign a Transaction ID to an event so that it can be processed in the QPI. Select Balanced to allocate transaction IDs to an agent based on the setting 32-24-32. Select IO Bias to allocate RTIDs based on the setting 32-16-40. The options are **Balanced** and IO Bias.

QPI (Quick Path Interconnect) Links Speed

This feature is used to set data transfer speed for QPI Link connections. The options are Slow-Mode and **Full-Speed**.

QPI Frequency

Use this feature to select the desired QPI frequency. The options are **Auto**, 4.800GT, 5.866GT, 6.400GT.

QPI L0s and L1

Select Enabled to lower QPI power state to reduce power consumption. L0s and L1 are automatically selected by the motherboard. The options are **Enabled** and Disabled.

Memory Frequency

This feature forces a DDR3 memory module to run at a specific frequency. The available options are **Auto**, Force DDR-800, Force DDR-1066, Force DDR-1333, and Force SPD.

Memory Mode

If this item is set to Independent, all DIMMs are available to the operating system. If this item is set to Channel Mirroring, the motherboard maintains two identical copies of all data in memory for redundancy. If this item is set to Lockstep, the motherboard uses two areas of memory to run the same set of operations in parallel. Select Sparing to use memory sparing and create data redundancy in memory modules for data security. (Sparing is supported by the 5600 processor.) The options are **Independent**, Channel Mirroring, Sparing, and Lockstep.

Demand Scrubbing

It is a memory error-correction scheme where the processor writes corrected data back into the memory block from where it was read by the processor. The options are Enabled and **Disabled**.

Patrol Scrubbing

It is a memory error-correction scheme that works in the background looking for and correcting resident errors. The options are **Enabled** and Disabled.

Throttling - Closed Loop

Throttling improves reliability and reduces CPU power by automatic voltage control during CPU idle states. The options are **Enabled** and Disabled.

► NorthBridge Chipset Configuration

This feature allows the user to configure North Bridge settings. The items included in the submenu are listed below.

- **NB Revision:** This item displays North Bridge revision number.

Intel I/OAT

The Intel I/OAT (I/O Acceleration Technology) significantly reduces CPU overhead by leveraging CPU architectural improvements, freeing resources for more other tasks. The options are Disabled and **Enabled**.

DCA Technology (Available when Intel I/OAT is enabled)

Select Enabled to use Intel's DCA (Direct Cache Access) Technology to enhance data transfer efficiency. The options are **Enabled** and Disabled.

DCA Prefetch Delay

A DCA Prefetch is used with TOE components to prefetch data in order to shorten execution cycles and maximize data processing efficiency. Prefetching too frequently can saturate the cache directory and delay necessary cache accesses. This feature reduces or increases the frequency the system prefetches data. The options are [8], [16], [24], **[32]**, [40], [48], [56], [64], [72], [80], [88], [96], [104], [112], [120].

Intel VT-d

Select Enabled to enable Intel's Virtualization Technology support for Direct I/O VT-d by reporting the I/O device assignments to VMM through the DMAR ACPI Tables. This feature offers fully-protected I/O resource-sharing across the Intel platforms, providing the user with greater reliability, security and availability in networking and data-sharing. The options are **Enabled** and Disabled.

Active State Power Management

Select Enabled to use the power management for signal transactions between the PCI Express L0 and L1 Links. Select Enabled to configure PCI-Exp. L0 and L1 Link power states. The options are **Disabled** and Enabled.

IOH PCI-E Max Payload Size

Some add-on cards perform faster with the coalesce feature, which limits the payload size to 128B; while others, with a payload size of 256B which inhibits the coalesce feature. Please refer to your add-on card user guide for the desired setting. The options are **256B** and 128B.

► South Bridge Configuration**USB Functions**

Select Enabled to use USB devices. The Options are: Disabled and **Enabled**.

Legacy USB Support

Select Enabled to use Legacy USB devices. If this item is set to Auto, Legacy USB support will be automatically enabled if a legacy USB device is installed on the motherboard, and vice versa. The settings are Disabled, **Enabled** and Auto.

Port60h/64h Emulation

Select Enabled to enable 60h/64h emulation for complete USB keyboard support for operating systems that are not compatible with USB devices. The options are Enabled and **Disabled**.

USB 2.0 Controller (Available when the item: USB Functions is disabled)

This item indicates if the onboard USB 2.0 controller is activated.

USB 2.0 Controller Mode

This setting allows you to select the USB 2.0 Controller mode. The options are **Hi-Speed (480 Mbps)** and Full Speed (12 Mbps).

BIOS EHCI Hand-Off

Select Enabled to enable BIOS Enhanced Host Controller Interface support to provide a workaround solution for an operating system that does not support EHCI Hand-Off. When enabled, the EHCI Interface will be changed from the BIOS-controlled to the OS-controlled. The options are Disabled and **Enabled**.

► IDE/SATA Configuration

When this submenu is selected, the AMI BIOS automatically detects the presence of the IDE devices and displays the following items:

SATA#1 Configuration

If Compatible is selected, it sets SATA#1 to legacy compatibility mode. Select Enhanced to set SATA#1 to native SATA mode. The options are Disabled, Compatible and **Enhanced**.

Configure SATA#1 as

This feature allows the user to select the drive type for SATA#1. The options are **IDE**, RAID and AHCI. (When RAID is selected, the items: "AHCI CodeBase" and "ICH RAID Code Base" will appear. When AHCI is selected, the item "AHCI CodeBase" will be available.)

AHCI CodeBase (Available when RAID or AHCI is selected)

Select BIOS Native Module to use BIOS Native Mode for AHCI Interface (Advanced Host Controller Interface). Select Intel AHCI ROM to use the Intel AHCI ROM for AHCI Interface. (Take caution when using this function.

This feature is for advanced programmers only.) The options are BIOS Native Module and **Intel AHCI ROM**. If the item is set to "IDE", the following item will display.

ICH RAID Code Base (Available when the option-RAID is selected)

Select Intel to enable Intel's SATA RAID firmware to configure Intel SATA RAID settings. Select Adaptec to enable Adaptec's firmware to configure Adaptec SATA RAID settings. The options are **Intel** and Adaptec.

SATA#2 Configuration (Available when the option "IDE" is selected)

Selecting Enhanced will set SATA#2 to native SATA mode. The options are Disabled, and **Enhanced**.

IDE Detect Timeout (sec)

Use this item to set the timeout value for the BIOS to detect the ATA, ATAPI devices installed in the system. The options are 0 (sec), 5, 10, 15, 20, 25, 30, and **35**.

Primary IDE Master/Slave, Secondary IDE Master/Slave, Third IDE Master, and Fourth IDE Master

These settings allow the user to set the parameters of the slots indicated above. Press <Enter> to activate the following submenu. Set the correct configurations accordingly. The items included in the submenu are listed below.

Type

Use this item to select the type of device connected to the system. The options are Not Installed, **Auto**, CD/DVD and ARMD.

LBA/Large Mode

LBA (Logical Block Addressing) is a method of addressing data on a disk drive. In the LBA mode, the maximum drive capacity is 137 GB. For drive capacities over 137 GB, your system must support 48-bit LBA mode addressing. If not, contact your manufacturer or install an ATA/133 IDE controller card that supports 48-bit LBA mode. The options are Disabled and **Auto**.

Block (Multi-Sector Transfer)

Block Mode boosts the IDE drive performance by increasing the amount of data transferred. Only 512 bytes of data can be transferred per interrupt if Block Mode is not used. Block Mode allows transfers of up to 64 KB per interrupt. Select Disabled to allow data to be transferred from and to the device one sector at a time. Select Auto to allow data transfer from and to the device occur multiple sectors at a time if the device supports it. The options are **Auto** and Disabled.

PIO Mode

The IDE PIO (Programmable I/O) Mode programs timing cycles between the IDE drive and the programmable IDE controller. As the PIO mode increases, the cycle time decreases. The options are **Auto**, 0, 1, 2, 3, and 4.

Select Auto to allow the AMI BIOS to automatically detect the PIO mode. Use this value if the IDE disk drive support cannot be determined.

Select 0 ~ 4 to allow the AMI BIOS to use PIO mode 0 ~ 4. It has a data transfer rate of 3.3 MB/s ~ 16.6 MB/s. See the table below.

PIO Mode Select Options

Option Selected	PIO Mode	Max. Transfer Rate
0	PIO Mode 0	3.3 MB/s
1	PIO Mode 1	5.2 MB/s
2	PIO Mode 2	8.3 MB/s
3	PIO Mode 3	11.1 MB/s
4	PIO Mode 4	16.6 MB/s

DMA Mode

Select Auto to allow the BIOS to automatically detect IDE DMA mode when the IDE disk drive support cannot be determined. The options are **Auto**, SWDMA, MWDMA, and UDMA. See the table below for DMA Mode Select Options.

DMA Mode Select Options

Option Selected	DMA Mode	Max. Transfer Rate
SWDMA 0	Single-Word DMA 0	2.1 MB/s
SWDMA1	Single-Word DMA 1	4.2 MB/s
SWDMA 2	Single-Word DMA 2	8.3MB/s
MWDMA 0	Multi-Word DMA 0	4.2 MB/s
MWDMA1	Multi-Word DMA 1	13.3 MB/s
MWDMA 2	Multi-Word DMA 2	16.6 MB/s
UDMA 0	Ultra DMA 0	16.6 MB/s
UDMA 1	Ultra DMA 1	25 MB/s
UDMA 2	Ultra DMA 2	33.3 MB/s
UDMA 3	Ultra DMA 3	44.4 MB/s
UDMA 4	Ultra DMA 4	66.6 MB/s
UDMA5	Ultra DMA 5	100 MB/s
UDMA 6	Ultra DMA 6	133 MB/s

S.M.A.R.T.

Self-Monitoring Analysis and Reporting Technology (SMART) can help predict impending drive failures. Select Auto to allow the AMI BIOS to automatically detect hard disk drive support. Select Disabled to prevent the AMI BIOS from using

the S.M.A.R.T. Select Enabled to allow the AMI BIOS to use the S.M.A.R.T. to support hard drive disk. The options are Disabled, Enabled, and **Auto**.

32Bit Data Transfer

Select Enable to enable 32-bit IDE data transfer support. The options are **Enabled** and Disabled.

►PCI/PnP Configuration

Clear NVRAM

Select Yes to clear the Non-Volatile Random Access (Flash) Memory (NVRAM) during system boot. The options are **No** and Yes.

Plug & Play OS

Selecting Yes allows the OS to configure Plug & Play devices. (This is not required for system boot if your system has an OS that supports Plug & Play.) Select **No** to allow the AMI BIOS to configure all devices in the system.

PCI Latency Timer

This feature sets the latency Timer for each PCI device installed on a PCI bus. Select 64 to set the PCI latency Timer to 64 PCI clock cycles. The options are 32, **64**, 96, 128, 160, 192, 224 and 248.

PCI IDE BusMaster

When this item is enabled, the BIOS uses PCI bus mastering for reading/writing to IDE drives. The options are Disabled and **Enabled**.

SR-IOV Supported

Single Root I/O Virtualization is an industry-standard mechanism that allows devices to be shared simultaneously among several virtual machines. SR-IOV is capable of partitioning a PCI function into several virtual interfaces in order to share the resources of a PCI Express (PCIe) device under a virtual environment. The options are **Disabled** and Enabled.

Slot 1 PCI 33MHz/Slot 2 PCI 33MHz/Slot 3 PCIE x4 in X8 Slot/Slot 4 PCIE x8/Slot 5 PCIE x4 in x8 Slot/Slot 6 PCIE x8 in x16 Slot

This feature allows you to Enable or Disable any of the PCI slots indicated above. The options are **Enable** and Disable.

Onboard LAN Option ROM Select

Select iSCSI to use iSCSI Option ROM to boot the computer using a network device. Select PXE to use PXE Option ROMs to boot the computer using a network device. The options are iSCSI and **PXE**.

Load Onboard LAN1 Option ROM/Load Onboard LAN2 Option ROM

Select Enabled to boot the computer using a network connection as specified. The default setting for Onboard LAN1 is **Enabled**. The default setting for Onboard LAN2 is **Disabled**.

Load Onboard SAS Option ROM (Available when SAS is enabled on the X8DTL-3/-3F)

Select Enabled to boot the computer using a SAS connection. The options are **Enabled** and Disabled.

Boots Graphics Adapter Priority

Use this feature to specify which graphics controller to be used as the primary boot device. The options are **Onboard VGA** and Offboard VGA.

► Super IO Device Configuration

Serial Port1 Address/ Serial Port2 Address

This option specifies the base I/O port address and the Interrupt Request address of Serial Port 1 or Serial Port 2. Select Disabled to prevent the serial port from accessing any system resources. When this option is set to Disabled, the serial port physically becomes unavailable. Select 3F8/IRQ4 to allow the serial port to use 3F8 as its I/O port address and IRQ 4 as its interrupt address. The options for Serial Port1 are Disabled, **3F8/IRQ4**, 2F8/IRQ3, 3E8/IRQ4, 2E8/IRQ3. The options for Serial Port2 are Disabled, 3F8/IRQ4, **2F8/IRQ3**, 3E8/IRQ4, and 2E8/IRQ3.

Serial Port 2 Attribute

This feature allows the user to set Serial Port 2 as a normal serial port or a virtual COM port for Serial-Over-LAN (SOL). The options are **SOL** and COM.

► Remote Access Configuration

Remote Access

This allows the user to enable Remote Access support. The options are **Enabled** and Disabled. If Remote Access is set to Enabled, the following items will display:

Serial Port Number

This feature allows the user to decide which serial port to use for Console Redirection. The options are COM 1 and **COM 2**.

Base Address, IRQ

This item displays the based address and IRQ of the serial port specified above. The default setting is **2F8h, 3**.

Serial Port Mode

This feature allows the user to set the serial port mode for Console Redirection. The options are **115200 8, n 1**; 57600 8, n, 1; 38400 8, n, 1; 19200 8, n, 1; and 9600 8, n, 1.

Flow Control

This feature allows the user to set the flow control for Console Redirection. The options are **None**, Hardware, and Software.

Redirection After BIOS POST

Select Disabled to turn off Console Redirection after Power-On Self-Test (POST). Select Always to keep Console Redirection active all the time after POST. (**Note:** This setting may not be supported by some operating systems.) Select Boot Loader to keep Console Redirection active during POST and when Boot Loader is being loaded. The options are Disabled, Boot Loader, and **Always**.

Terminal Type

This feature allows the user to select the target terminal type for Console Redirection. The options are ANSI, **VT100**, and VT-UTF8.

VT-UTF8 Combo Key Support

Select Enabled to enable a terminal keyboard definition that provides a way to send commands from a remote console. The options are **Enabled** and Disabled.

Sredir Memory Display Delay

This feature defines the length of time in seconds to display memory information. The options are **No Delay**, Delay 1 Sec, Delay 2 Sec, and Delay 4 Sec.

► Hardware Health Event Monitoring

This feature allows the user to monitor system health and review the status of each item as displayed.

CPU Overheat Alarm

This option allows the user to select the CPU Overheat Alarm setting which determines when the CPU OH alarm will be activated to provide warning of possible CPU overheat.



Warning! 1. Any temperature that exceeds the CPU threshold temperature predefined by the CPU manufacturer may result in CPU overheat or system instability. When the CPU temperature reaches this predefined threshold, the CPU and system cooling fans will run at full speed. 2. To

avoid possible system overheating, please be sure to provide adequate airflow to your system.

The options are:

- The Early Alarm: Select this setting to trigger the CPU overheat alarm (including the LED and the buzzer) as soon as the CPU temperature reaches the CPU overheat threshold as predefined by the CPU manufacturer.
- **The Default Alarm:** Select this setting to trigger the CPU overheat alarm (including the LED and the buzzer) when the CPU temperature reaches about 5°C above the threshold temperature as predefined by the CPU manufacturer to give the CPU and system fans additional time needed for CPU and system cooling. In both the alarms above, please take immediate action as shown below.

CPU 1 Temperature/CPU 2 Temperature/IOH Temperature/System Temperature

This feature displays current temperature readings for CPU 1, CPU 2, and the System.

The following items will be displayed for your reference only:

CPU 1 Temperature/CPU 2 Temperature

The CPU Temperature feature will display the CPU temperature status as detected by the BIOS:

Low – This level is considered as the ‘normal’ operating state. The CPU temperature is well below the CPU ‘Temperature Tolerance’. The motherboard fans and CPU will run normally as configured in the BIOS (Fan Speed Control).

User intervention: No action required.

Medium – The processor is running warmer. This is a ‘precautionary’ level and generally means that there may be factors contributing to this condition, but the CPU is still within its normal operating state and below the CPU ‘Temperature Tolerance’. The motherboard fans and CPU will run normally as configured in the BIOS. The fans may adjust to a faster speed depending on the Fan Speed Control settings.

User intervention: No action is required. However, consider checking the CPU fans and the chassis ventilation for blockage.

High – The processor is running hot. This is a ‘caution’ level since the CPU’s ‘Temperature Tolerance’ has been reached (or has been exceeded) and may activate an overheat alarm. The system may shut down if it continues for a long period to prevent damage to the CPU.

User intervention: If the system buzzer and Overheat LED has activated, take action immediately by checking the system fans, chassis ventilation and room temperature to correct any problems.

 **Notes:**

1. The CPU thermal technology that reports absolute temperatures (Celsius/Fahrenheit) has been upgraded to a more advanced feature by Intel in its newer processors. The basic concept is each CPU is embedded by unique temperature information that the motherboard can read. This 'Temperature Threshold' or 'Temperature Tolerance' has been assigned at the factory and is the baseline on which the motherboard takes action during different CPU temperature conditions (i.e., by increasing CPU Fan speed, triggering the Overheat Alarm, etc). Since CPUs can have different 'Temperature Tolerances', the installed CPU can now send information to the motherboard what its 'Temperature Tolerance' is, and not the other way around. This results in better CPU thermal management.

Supermicro has leveraged this feature by assigning a temperature status to certain thermal conditions in the processor (Low, Medium and High). This makes it easier for the user to understand the CPU's temperature status, rather than by just simply seeing a temperature reading (i.e., 25°C).

The information provided above is for your reference only. For more information on thermal management, please refer to Intel's Web site at www.Intel.com.

2. To avoid possible system overheating, please provide adequate airflow to the system.

System Temperature

The system temperature will be displayed (in degrees in Celsius and Fahrenheit) as detected by the BIOS.

Fan Speed Readings

This feature displays the fan speed readings from Fan 1 through Fan 6.

Fan Speed Control Modes

This feature allows the user to decide how the system controls the speeds of the onboard fans. The CPU temperature and the fan speed are correlated. When the CPU on-die temperature increases, the fan speed will also increase for effective system cooling. Select "Full Speed/FS" to allow the onboard fans to run at full speed for maximum cooling. The FS setting is recommended for special system configuration or debugging. Select "Performance/PF" for better system cooling. The PF setting is recommended for high-power-consuming and high-density systems. Select "Balanced/BL" for the onboard fans to run at a speed that will balance the needs between system cooling and power saving. The BL setting is recommended for regular systems with normal hardware configurations. Select "Energy Saving/ES" for best power efficiency and maximum quietness. The Options are: Full Speed/FS, Performance/PF, **Balanced/BL**, and Energy Saving/ES.

Voltage Readings

The following voltage readings will be displayed.

CPU1 Vcore, CPU2 Vcore, CPU1 DIMM, CPU2 DIMM, 5V, 5VSB, 12V, -12V, 3.3Vcc, 3.3VSB, VBAT and Vtt

►ACPI Configuration

Use this feature to configure Advanced Configuration and Power Interface (ACPI) power management settings for your system.

High Precision Event Timer

Select Enabled to activate the High Precision Event Timer (HPET) that produces periodic interrupts at a much higher frequency than a Real-time Clock (RTC) does in synchronizing multimedia streams, providing smooth playback and reducing the dependency on other timestamp calculation devices, such as an x86 RDTSC Instruction embedded in the CPU. The High Performance Event Timer is used to replace the 8254 Programmable Interval Timer. The options are **Enabled** and Disabled.

ACPI Aware O/S

Enable ACPI support if it is supported by the OS to control ACPI through the Operating System; otherwise, disable this feature. The options are **Yes** and No.

ACPI APIC Support

Select Enabled to include the ACPI APIC Table Pointer in the RSDT (Root System Description Table) pointer list. The options are **Enabled** and Disabled.

APIC ACPI SCI IRQ

When this item is set to Enabled, APIC ACPI SCI IRQ is supported by the system. The options are Enabled and **Disabled**.

Headless Mode

Select Enabled for the system to function normally without a keyboard, monitor and/or mouse attached. The options are Enabled and **Disabled**.

ACPI Version Features

Use this feature to select the appropriate ACPI Version for your system to ensure that the correct RSDP (Root System Description Pointer) Table is used by the system. The options are ACPI v1.0, **ACPI v2.0** and ACPI v3.0. For more information, please refer to ACPI's website at <http://www.acpi.info/>.

NUMA Support

Select Enabled to use the feature of Non-Uniform Memory Access to improve CPU performance. The options are **Enabled**, Disabled, and NUMA for SLES 11.

WHEA Support

Select Enabled to enable Windows Hardware Error Architecture (WHEA) support which will provide a common infrastructure for the system to handle hardware errors on Windows platforms in order to reduce system crashes due to hardware errors and to enhance system recovery and health monitoring. The default setting is **Enabled**.

► Trusted Computing (Available when a TPM device is detected and the TPM jumper is enabled)**TCG/TPM (Trusted Platform Module) Support**

Select Yes on this item and enable the TPM jumper on the motherboard to enable TCG (TPM 1.1/1.2)/TPM support in order to improve data integrity and network security. The options are **No** and Yes. If this feature is set to Yes, the following items will display:

Indicate Physical

Select Yes for the BIOS to show if a TPM Physical device is present. The options are **No** and Yes.

TPM Deactivated

Select Set to disable TPM support. Select Clear to enable TPM support. Select Don't Change to keep current TPM support settings. The options are **Don't change**, Set, and Clear.

TPM Owner

Select Don't Change to keep current TPM Owner settings. Select Enable Install to add a user to the TPM Owner account. Select Disable Install to prevent a user from adding a TPM Owner account. Select Clear to remove a user from the TPM Owner account. Select Don't Change to keep the current TPM Owner setting. The options are **Don't change**, Enable Install, Disable Install, and Clear.

TPM Enable/Disable Status

This item displays the status of TPM Enabled/Disabled state.

TPM Owner Status

This item displays the status of TPM Ownership.

► IPMI Configuration (For X8DTL-3F/iF only)

Intelligent Platform Management Interface (IPMI) is a set of common interfaces that IT administrators can use to monitor system health and to manage the system as a whole. For details on IPMI, please visit Intel's website at www.intel.com.

IPMI Firmware Revision: This item displays the current IPMI firmware revision.

Status of BMC

Baseboard Management Controller (BMC) manages the interface between system management software and platform hardware. This feature displays the status code of the BMC controller.

► View BMC System Event Log

This feature displays the BMC System Event Log (SEL). It shows the total number of entries of BMC System Events. To view an event, select an Entry Number and pressing <Enter> to display the information as shown in the screen.

- Total Number of Entries
- SEL Entry Number
- SEL Record ID
- SEL Record Type
- Event Timestamp
- Generator ID
- Event Message Format Version
- Event Sensor Type
- Event Sensor Number
- Event Dir Type
- Event Data.

Clear BMC System Event Log

Select OK and press the <Enter> key to clear the BMC system log. Select Cancel to keep the BMC System log. The options are **OK** and Cancel.

 **Caution:** Make sure that you no longer need any data stored in the event log before clearing the BMC Event Log because you will not be able to recover any data included in the event log once you've "cleared" it.

► Set LAN Configuration

Set this feature to configure the IPMI LAN adapter with a network address as shown in the following graphics.

Channel Number-This item displays the channel number of current LAN connection.

Channel Number Status - This feature displays the channel status for the channel number indicated above.

IP Address Source

Use this item to select the source of this machine's IP address. If Static is selected, you will need to know the IP address of this machine and enter it to the system manually in the field. If DHCP is selected, the BIOS will search for a DHCP (Dynamic Host Configuration Protocol) server in the network it is attached to and request the next available IP address. The options are **DHCP** and Static. The following items are assigned IP addresses automatically if DHCP is selected:

IP Address

Use this item to select the IP address for this machine. This should be in decimal and in dotted quad form (i.e., 192.168.10.253). The value of each three-digit number separated by dots should not exceed 255 as shown in the screen below.

Subnet Mask

This feature shows the network which subnet this machine belongs to. The value of each three-digit number separated by dots should not exceed 255.

Gateway Address

This is the IP address of the gateway in the network. This is usually a router.

Mac Address

The BIOS will automatically enter the Mac address of this machine; however it may be overwritten. Mac addresses are 6 two-digit hexadecimal numbers (Base 16, 0 ~ 9, A, B, C, D, E, F) separated by dots. (i.e., 00.30.48.D0.D4.60).

► Event Log Configuration

View Event Log

Use this option to view the System Event Log.

Mark all events as read

Select "OK" to mark all events as read. The options are OK and Cancel.

Clear event log

Select "OK" to clear all messages from the Event Log. The options are OK and Cancel.

PCIE Error Log

Select Yes to enable PCI-E error (PERR) logging. The options are Yes and No.

Memory ECC Error Log

Select Yes to activate and display ECC Memory Error event log. The options are Yes and No.

4-4 Security Settings

The AMI BIOS provides a Supervisor and a User password. If you use both passwords, the Supervisor password must be set first.

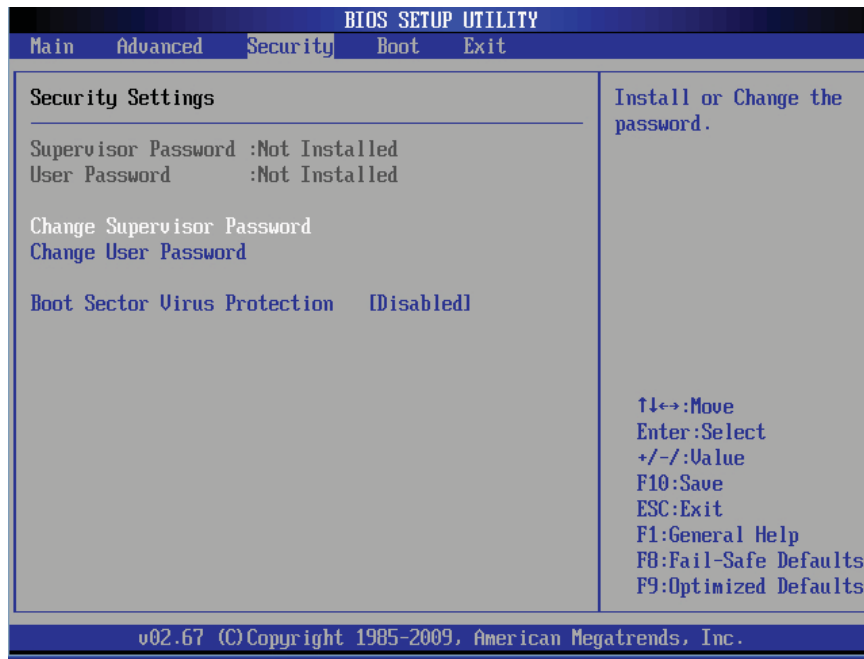

Supervisor Password

This item indicates if a Supervisor password has been entered for the system. "Not Installed" means a Supervisor password has not been used.

User Password

This item indicates if a user password has been entered for the system. "Not Installed" means that a user password has not been used.

Change Supervisor Password

Select this feature, press <Enter> to access the submenu, and enter a new Supervisor Password.

User Access Level (Available when Supervisor Password is set as above)

Select **Full Access** to grant the user full access to the Setup utility, and change Setup settings. Select **View Only** to grant the user access to the Setup utility and view the settings without making changes. Select **Limited** to allow the user to change selected settings such as Date and Time. Select **No Access** to prevent the user from accessing the Setup utility.

Change User Password

Select this feature, press <Enter> to access the submenu, and enter a new user Password.

Clear User Password (Available only when User Password has been set)

This item allows you to clear a user password after it has been entered.

Password Check

This item allows you to check a password after it has been entered. The options are **Setup** and **Always**.

Boot Sector Virus Protection

If this feature is enabled, the AMI BIOS displays a warning message when any program (or virus) issues a Disk Format command or attempts to write to the boot sector of the hard disk drive. The options are **Enabled** and **Disabled**.

4-5 Boot Configuration

Use this feature to configure boot settings.

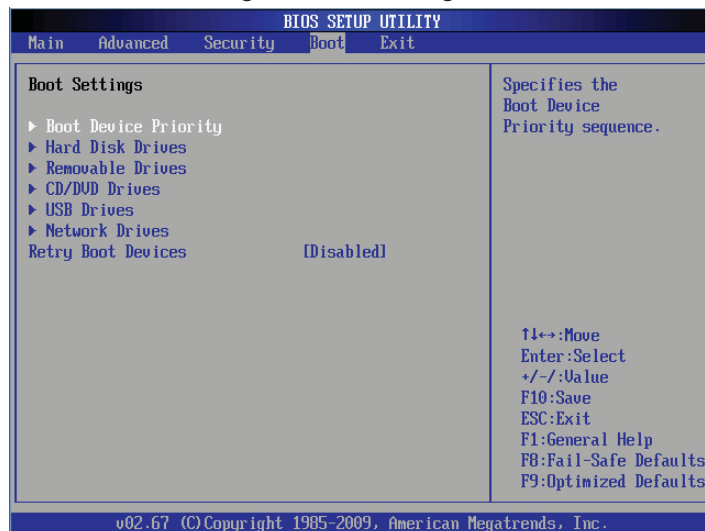

► **Boot Device Priority**

This feature allows the user to specify the priority sequence of boot devices, including the 1st boot device, 2nd boot device, etc. The options are Removable Devices, Hard Drive, CD/DVD, USB, Network, and Disabled.

- 1st Boot Device - [Removable Dev.]/2nd Boot Device - [CD/DVD]

► **Hard Disk Drives**

This feature allows the user to specify the boot sequence from all available hard disk drives. The settings are Disabled and a list of all hard disk drives that have been detected (i.e., 1st Drive, 2nd Drive, 3rd Drive, etc).

- 1st Drive

► **Removable Drives**

This feature allows the user to specify the boot sequence from available Removable Drives. The settings are 1st boot device, 2nd boot device, and Disabled.

- 1st Drive/2nd Drive

► **CD/DVD Drives**

This feature allows the user to specify the boot sequence from available CD/DVD Drives.

- 1st Drive/2nd Drive

► **USB Drives**

This feature allows the user to specify the boot sequence from available USB Drives.

► **Network Drives**

This feature allows the user to specify the boot sequence from available Network Drives.

Retry Boot Devices

If this feature is enabled, the system will continue to search for the next boot device to boot the system if the current boot device is not available. The options are Enabled, and **Disabled**.

4-6 Exit Options

Select the Exit tab from the AMI BIOS Setup utility screen to enter the Exit BIOS Setup screen.

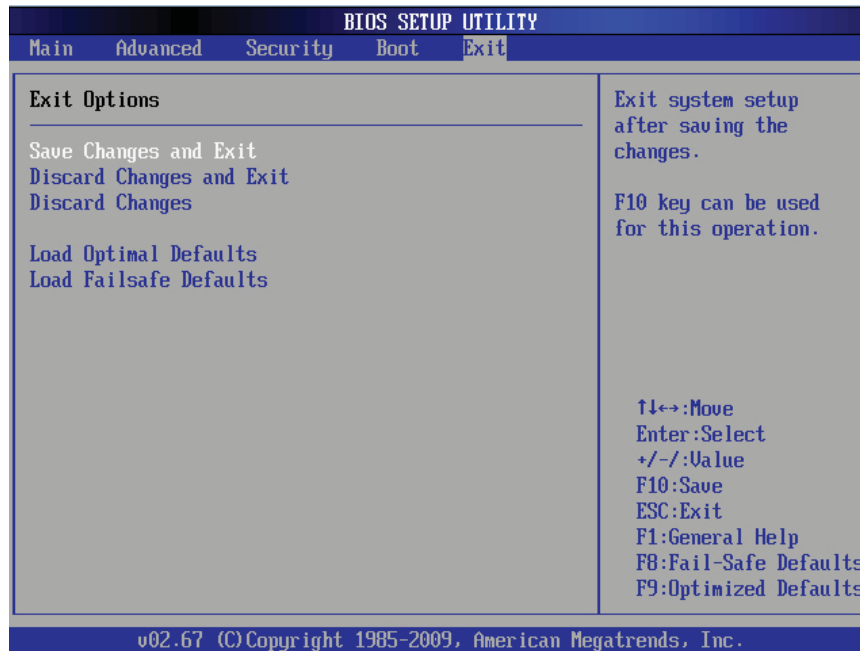

Save Changes and Exit

After configuring the setup settings, select this option to save the changes and exit the BIOS Setup utility. The system will then reboot, and new system parameters will become effective.

Discard Changes and Exit

Select this option to exit the BIOS Setup without making changes to the BIOS settings.

Discard Changes

Select this option to discard all the changes and return to the Setup utility.

Load Optimal Defaults

Select this feature for the AMI BIOS to automatically load Optimal Defaults to the BIOS Settings to maximize system performance. This option might not work best for some computer applications.

Load Fail-Safe Defaults

Select this feature for the AMI BIOS to automatically load Fail-Safe Defaults to the BIOS Settings for maximum system stability but not for maximum performance.

Notes

Appendix A

BIOS Error Beep Codes

During the POST (Power-On Self-Test) routines, which are performed each time the system is powered on, errors may occur.

Non-fatal errors are those which, in most cases, allow the system to continue the boot-up process. The error messages normally appear on the screen.

Fatal errors will not allow the system to continue the boot-up procedure. If a fatal error occurs, you should consult with your system manufacturer for possible repairs.

BIOS Error Beep Codes		
Beep Code	Error Message	Description
1 beep	Refresh	Circuits have been reset. (Ready to power up)
5 short beeps+1 long beep	Memory error	No memory detected in the system
8 beeps	Display memory read/write error	Video adapter missing or with faulty memory
1 high (pitch)+1 low (pitch) (siren-like alarm)	System Overheat	System overheat

Notes

Appendix B

Software Installation Instructions

B-1 Installing Software Programs

After you've installed the Windows Operating System, a screen as shown below will appear. You are ready to install software programs and drivers that have not yet been installed. To install these software programs and drivers, click the icons to the right of these items. (**Note:** To install the Windows OS, please refer to the instructions posted on our website at <http://www.supermicro.com/support/manuals/>.)

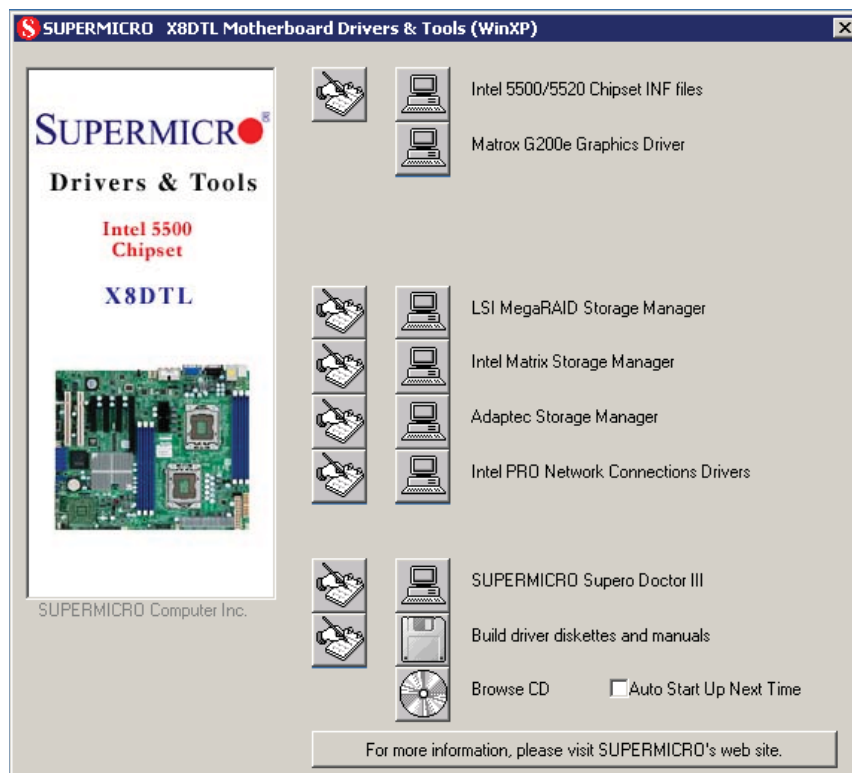

Driver/Tool Installation Display Screen



Note 1. Click the icons showing a hand writing on the paper to view the readme files for each item. Click on a computer icon to the right of an item to install an item (from top to the bottom) one at a time. After installing each item, you must reboot the system before proceeding with the next item on the list. The bottom icon with a CD on it allows you to view the entire contents of the CD.

Note 2. When making a storage driver diskette by booting into a Driver CD, please set the SATA Configuration to "Compatible Mode" and configure SATA as IDE in the BIOS Setup. After making the driver diskette, be sure to change the SATA settings back to your original settings.

B-2 Configuring Supero Doctor III

The Supero Doctor III program is a web-based management tool that supports remote management capability. It includes Remote and Local Management tools. The local management is called the SD III Client. The Supero Doctor III program included on the CDROM that came with your motherboard allows you to monitor the environment and operations of your system. Supero Doctor III displays crucial system information such as CPU temperature, system voltages and fan status. See the Figure below for a display of the Supero Doctor III interface.

 **Note:** 1 The default user name and password are ADMIN.

Note 2: In the Windows OS environment, the Supero Doctor III settings take precedence over the BIOS settings. When first installed, Supero Doctor III adopts the temperature threshold settings previously set in BIOS. Any subsequent changes to these thresholds must be made within Supero Doctor, since the SD III settings override the BIOS settings. For the Windows OS to adopt the BIOS temperature threshold settings, please change the SDIII settings to be the same as those set in BIOS.

Supero Doctor III Interface Display Screen-I (Health Information)



Supero Doctor III Interface Display Screen-II (Remote Control)



 **Note:** SD III Software Revision 1.0 can be downloaded from our Web site at: ftp://ftp.supermicro.com/utility/Supero_Doctor_III/. You can also download SDIII User's Guide at: <http://www.supermicro.com/PRODUCT/Manuals/SDIII/UserGuide.pdf>. For Linux, we will still recommend that you use Supero Doctor II.

Notes

(Disclaimer Continued)

The products sold by Supermicro are not intended for and will not be used in life support systems, medical equipment, nuclear facilities or systems, aircraft, aircraft devices, aircraft/emergency communication devices or other critical systems whose failure to perform be reasonably expected to result in significant injury or loss of life or catastrophic property damage. Accordingly, Supermicro disclaims any and all liability, and should buyer use or sell such products for use in such ultra-hazardous applications, it does so entirely at its own risk. Furthermore, buyer agrees to fully indemnify, defend and hold Supermicro harmless for and against any and all claims, demands, actions, litigation, and proceedings of any kind arising out of or related to such ultra-hazardous use or sale.